

OPERATION MANUAL



brother®

“IMPORTANT SAFETY INSTRUCTIONS”

When using this machine, basic safety precautions should always be taken, including the following:

“Read all instructions before using.”

DANGER — To reduce the risk of electric shock.

1. The machine should never be left unattended while plugged in. Always unplug the machine from the electrical outlet immediately after using and before cleaning.
2. Always unplug before changing the light bulb. Replace bulb with same type rated 12V 5 watts.

WARNING — To reduce the risk of burns, fire, electric shock, or injury to persons.

1. Do not allow this machine to be used as a toy. Close attention is necessary when the machine is used by or near children.
2. Use this machine only for its intended use as described in this manual. Use only accessories recommended by the manufacturer as contained in this manual.
3. Never operate this machine if it has a damaged cord or plug, if it is not working properly, if it has been dropped or damaged, or dropped into water. Return the machine to the nearest authorized dealer or service center for examination, repair, electrical or mechanical adjustment.
4. Never operate the machine with any air openings blocked. Keep ventilation openings of the machine and foot control free from the accumulation of lint, dust, and loose cloth.
5. Never drop or insert any object into any opening.
6. Do not use outdoors.
7. Do not operate where aerosol (spray) products are being used or where oxygen is being administered.
8. To disconnect, turn the main switch to the symbol “O” position which represents off, then remove plug from outlet.
9. Do not unplug by pulling on cord. To unplug, grasp the plug, not the cord.
10. Keep fingers away from all moving parts. Special care is required around the machine needle.
11. Always use the proper needle plate. The wrong plate can cause the needle to break.
12. Do not use bent needles.
13. Do not pull or push fabric while stitching. It may deflect the needle causing it to break.
14. Switch the machine to the symbol “O” position when making any adjustments in the needle area, such as threading needle, changing needle, threading bobbin, or changing presser foot, and the like.
15. Always unplug the machine from the electrical outlet when removing covers, lubricating, or when making any other user servicing adjustments mentioned in the instruction manual.
16. This sewing machine is not intended for use by young children or infirm persons without supervision.
17. Young children should be supervised to ensure that they do not play with this machine.

“SAVE THESE INSTRUCTIONS”

“This machine is intended for household use.”

FOR USERS IN THE UK, EIRE, MALTA AND CYPRUS ONLY.

If this machine is fitted with a three-pin non-rewireable BS plug then please read the following.

IMPORTANT

If the available socket outlet is not suitable for the plug supplied with this equipment, it should be cut off and an appropriate three-pin plug fitted. With alternative plugs an approved fuse must be fitted in the plug.

NOTE

The plug served from the main lead must be destroyed as a plug with bared flexible cords is hazardous if engaged in a live socket outlet. In the event of replacing the plug fuse, use a fuse approved by ASTA to BS 1362, i.e. carrying the  mark, rating as marked on plug.

Always replace the fuse cover, never use plugs with the fuse cover omitted.

WARNING

DO NOT CONNECT EITHER WIRE TO THE EARTH TERMINAL WHICH IS MARKED WITH THE LETTER 'E', BY THE EARTH SYMBOL  OR COLOURED GREEN OR YELLOW.

The wires in this main lead are coloured in accordance with the following code:

Blue Neutral

Brown Live

As the colours of the wiring in the main lead of this appliance may not correspond with the coloured markings identifying the terminals in your plug, proceed as follows.

The wire which is coloured blue must be connected to the terminal which is marked with the letter 'N' or coloured black or blue.

The wire which is coloured brown must be connected to the terminal which is marked with the letter 'L' or coloured red or brown.

CONGRATULATIONS ON CHOOSING OUR MACHINE

Your machine is the most advanced computerized home use this machine available. To fully enjoy all the features incorporated we suggest that you study this booklet.

PLEASE READ BEFORE USING THIS MACHINE

For safe operation

1. Be sure to keep your eye on the needle while sewing. Do not touch the pulley, thread take-up, needle, or other moving parts.
2. Remember to turn off the power switch and unplug the cord when:
 - Operation is completed
 - Replacing or removing the needle or any other parts
 - A power failure occurs during use
 - Maintaining the machine
 - Leaving the machine unattended.
3. Do not store anything on the foot controller.
4. Plug the machine directly into the wall. Do not use extension cords.

For a longer service life

1. When storing this machine, avoid direct sunlight and high humidity locations. Do not store the machine beside a space heater, iron, or other hot objects.
2. Use only neutral soaps or detergents to clean the case. Benzene, thinner, and scouring powders can damage the case and machine, and should never be used.
3. Do not drop or hit the machine.
4. Always consult the operation manual when replacing or installing any assemblies, the presser feet, needle, or other parts to assure correct installation.

For repair or adjustment

In the event a malfunction occurs or adjustment is required, first follow the troubleshooting table in the back of the operation manual to inspect and adjust the machine yourself. If the problem persists, please consult your nearest authorized Brother service center.

CONTENTS

CHAPTER 1

SETTING UP

| | |
|---|----|
| PRINCIPAL PARTS | 5 |
| OTHER INCLUDED ACCESSORIES | 7 |
| OPTIONS | 8 |
| POWER SUPPLY | 9 |
| SELECTION KEYS | 10 |
| Screen messages guide you through each operation | 10 |
| OPERATION BUTTONS | 11 |
| Using the operation buttons | 11 |
| USING THE SCREEN KEYS | 12 |
| Examples of the keys on LCD | 12 |
| About the screen | 12 |
| If the LCD is hard to see when the power is turned on | 13 |
| Adjusting the brightness of the LCD | 13 |
| HOW TO USE THE LANGUAGE SELECTION KEY | 14 |
| How to clear the language selection | 15 |
| BOBBIN WINDING / BOBBIN THREAD | |
| SETTING | 16 |
| Winding the bobbin and setting the bobbin thread | 16 |
| Setting the bobbin | 18 |
| UPPER THREADING | 19 |
| Thread according to number and arrow marks on machine | 19 |
| Auto-threading device | 20 |
| Using the extra spool pin and the net | 21 |
| START/STOP | 22 |
| "START/STOP" button | 22 |
| Foot controller | 22 |
| Mounting and Using the Knee Lifter | 23 |
| STITCH WIDTH AND STITCH LENGTH | 24 |
| Stitch width | 24 |
| Stitch length | 25 |
| Quick adjustment reference chart for stitch width and stitch length | 27 |
| THREAD TENSION | 29 |
| Correct tension | 29 |
| Loosen tension by touching "◀" (Weak) | 29 |
| Tighten tension by touching "▶" (Strong) | 30 |
| Except "UTILITY STITCH" | 30 |
| CHANGING THE PRESSER FOOT | 31 |
| Change the presser foot according to the LCD message | 31 |
| Installing embroidery foot "Q" | 31 |
| Changing the embroidery foot | 32 |
| Feed dog adjustment | 33 |
| CHANGING THE NEEDLE | 34 |
| Setting the needle securely | 34 |
| Checking needle | 34 |
| MACHINE OPERATION KEYS | 35 |







CHAPTER 2

1. SEWING

| | |
|----------------------------------|----|
| TRIAL SEWING | 36 |
| Sewing by using "UTILITY STITCH" | 36 |

| | |
|--|----|
| AUTOMATIC REINFORCEMENT STITCHING | 38 |
| Cancelling automatic reinforcement stitching | 38 |
| AUTOMATIC THREAD CUTTING | 39 |
| Cancelling programmed automatic thread cutting | 39 |
| UTILITY STITCH SELECTION | 40 |
| USEFUL SKILLS | 42 |
| The "📖" key | 42 |
| Sewing corners | 43 |
| Sewing thick seams | 43 |
| Sewing curves | 43 |
| Sewing thick fabric | 44 |
| Sewing thin fabric | 44 |

2. UTILITY STITCHES

| | |
|--|----|
| STRAIGHT STITCHES | 45 |
| For reinforcement stretching on stretch fabric | 46 |
| Changing the stitch length | 46 |
| Changing the needle position | 46 |
| ADAPTER FOR LOW SHANK ATTACHMENTS | 47 |
| Included accessories | 47 |
| Installation of walking foot | 47 |
| ZIGZAG STITCHES | 48 |
| Overcasting (using a zigzag stitch) | 48 |
| Applique (using a zigzag stitch) | 48 |
| Patchwork (for crazy quilt) | 48 |
| OVERCASTING | 49 |
| When using  ,  or  stitches | 49 |
| When using  ,  or  stitches | 49 |
| OVERCASTING (When using the side cutter) | 50 |
| BLIND HEM STITCHES | 52 |
| Adjusting the needle drop position | 53 |
| BUTTONHOLE STITCHES | 54 |
| Order of one cycle | 56 |
| Sewing stretch fabrics | 56 |
| Buttons that do not fit into the guide plate (Odd-shaped buttons) | 57 |
| Changing the stitch length | 57 |
| Changing the stitch width | 57 |
| BAR TACKING | 58 |
| Thick fabrics | 59 |
| Changing the bar tack stitch length | 59 |
| Changing the bar tack stitch width | 59 |
| DARNING | 60 |
| Changing the length of the darning stitch | 61 |
| Changing the bar tack stitch width | 61 |
| Darning stitch cycle | 61 |
| TAPE ATTACHING | 62 |
| EYELET STITCH | 63 |
| Size of eyelet (Actual size) | 63 |
| BUTTON SEWING | 64 |
| Attaching buttons with four holes | 65 |
| Attaching a shank to the button | 65 |
| BASTING | 66 |
| ZIPPER INSERTION (CENTERED AND SIDE APPLICATION) | 67 |
| Centered application | 67 |
| Side application | 68 |
| DART SEAM | 70 |
| GATHERING | 71 |
| Pulling out the bobbin thread | 72 |
| PINTUCK | 73 |

Setting Up

Sewing

Utility Stitches

Characters and Decorative Stitches

Embroidering

Editing Patterns

Retrieving

My Custom Stitches™

Maintenance



Error Messages

Trouble shooting





Sewing Chart

Patterns (Programmed in Machine)

Patterns (Memory Card)

| | |
|---|----|
| FLAT FELL SEAM | 75 |
| Finished flat fell seam | 76 |
| APPLIQUES | 77 |
| Sewing the applique around corners | 77 |
| APPLIQUE QUILTS | 78 |
| SCALLOP STITCH | 79 |
| SMOCKING STITCH | 80 |
| PATCHWORK STITCH | 81 |
| FAGOTING | 82 |
| DECORATIVE STITCHING | 83 |
| Decorative stitching | 83 |
| Shell tacking | 83 |
| HEM-STITCH (HEIRLOOM STITCH) | 84 |
| “  ” hem-stitching | 84 |
| “  ” hem-stitching | 85 |
| LATERAL SEWING (STRAIGHT/ZIGZAG) | 86 |

3. CHARACTERS AND DECORATIVE STITCHES

| | |
|--|-----------|
| | 88 |
| CHARACTER SEWING | 88 |
| Combinations of characters | 89 |
| DECORATIVE STITCHES | 90 |
| DECORATIVE STITCHES (7 mm) | 91 |
| SATIN STITCHES | 92 |
| CROSS STITCHING | 93 |
| CHARACTER AND DECORATIVE STITCH ADJUSTMENT | 94 |
| Changing the pattern size (Actual size) | 94 |
| Single/repeat sewing | 94 |
| Elongation | 95 |
| Changing the stitch length and the stitch width | 96 |
| Customize patterns by combining satin stitches using the “  ” and “  ” keys | 97 |
| Changing Mirror Image [Left and Right (the “  ” key), and Top and Bottom (the “  ” key)] | 99 |
| Confirming entry of combined stitch patterns | 100 |
| Saving combined stitch patterns | 100 |
| SEWING | 102 |
| Sewing attractive finishes | 102 |
| Using a pattern sheet | 102 |
| Sewing | 103 |
| ADJUSTING STITCH PATTERNS | 105 |

4. EMBROIDERING

| | |
|---|------------|
| | 106 |
| PREPARATION BEFORE SEWING | 106 |
| Attaching embroidery foot “Q” | 106 |
| Fitting embroidery unit | 107 |
| Removing the embroidery unit | 108 |
| Placing the embroidery unit into its case | 108 |
| Initializing the embroidery unit | 109 |
| SELECTING AND SEWING PATTERNS | 110 |
| Selecting alphabetical characters | 110 |
| Selecting one-point patterns | 111 |
| Selecting frame patterns | 112 |
| Selecting floral alphabets | 113 |
| Selecting patterns from a memory card | 114 |
| MEMORY | 116 |
| Saving a pattern combination in memory | 116 |

| | |
|--|-----|
| EMBROIDERING | 117 |
| Embroidering attractive finishes | 117 |
| Setting the fabric into the embroidery frame | 117 |
| Fitting the embroidery frame to the embroidery unit | 119 |
| Embroidering | 120 |
| Embroidering a single color pattern when “MULTI COLOR” is displayed | 122 |
| Changing the stitch density for characters and some frame patterns | 122 |
| MOVING THE LOCATION (LAYOUT) | 123 |
| Moving the embroidery location | 124 |
| Checking the embroidering area | 124 |
| Embroidering from a specific starting point | 125 |
| Changing the pattern direction | 125 |
| Reversing patterns | 126 |
| Using the “IMAGE” key | 126 |
| Changing the size of characters, frame patterns and pattern | 127 |
| ADJUSTMENTS DURING THE EMBROIDERY PROCESS | 129 |
| If the thread breaks during embroidering | 129 |
| Continuing a pattern after the power has been momentarily turned off | 129 |
| When sewing again from the beginning..... | 130 |
| EMBROIDERY APPLICATIONS | 131 |
| Linking characters | 131 |
| Embroidering appliques (using a frame pattern) | 132 |
| Embroidering onto small pieces of fabric or onto corners | 134 |



5. EDITING EMBROIDERY PATTERNS

| | |
|--|------------|
| | 135 |
| EMBROIDERY EDITING CAPABILITIES | 135 |
| Explanation of the Editing Functions | 135 |
| HOW TO EDIT | 136 |
| Character Editing | 137 |
| One-point Editing | 143 |
| Border Pattern Editing | 145 |
| Editing Patterns on Embroidery Cards (sold separately) | 146 |
| Editing Combinations | 147 |
| SAVING A PATTERN COMBINATION TO MEMORY | 151 |
| Let's Sew | 153 |
| CORRECTING EDITED PATTERNS | 154 |
| Correcting another stitch pattern during editing | 154 |
| Correcting stitch patterns after editing | 155 |

6. RETRIEVING

| | |
|------------------------------------|------------|
| | 156 |
| RETRIEVING CHARACTERS AND PATTERNS | 156 |
| RETRIEVING AN EMBROIDERY PATTERN | 157 |
| RETRIEVING AN EDITED PATTERN | 158 |
| DELETING A STORED PATTERN | 159 |

**7. MY CUSTOM STITCH™
(Function for making own stitch Designs)**

_____ **160**
 MAKING THE ILLUSTRATION _____ 160
 GENERATING THE DATA _____ 162
 EDITING AN EXISTING “” _____ 164
 Moving a point _____ 164
 Moving part or all of a pattern _____ 165
 Inserting new points _____ 165
 Once you have finished editing _____ 166
 STORING THE “” WHICH YOU HAVE
 ENTERED _____ 167
 RETRIEVING A “” _____ 168

MAINTENANCE

_____ **169**
 CLEANING _____ 169
 Cleaning the screen _____ 169
 Cleaning the machine surface _____ 169
 Cleaning the shuttle _____ 169
 CHANGING THE LIGHT BULB _____ 171
 RELATED CHART OF SEWING FABRICS,
 THREAD AND NEEDLE _____ 172

ERROR MESSAGES

_____ **173**
 Warning messages _____ 173
 Instruction messages _____ 178
 Alarms _____ 179

TROUBLESHOOTING

_____ **180**
 USING THE “OPERATION GUIDE” KEY _____ 180
 Trouble with threads and stitches _____ 181
 Mechanical trouble _____ 182

SEWING CHART

_____ **183**

**PATTERNS
(PROGRAMMED IN MACHINE)**

_____ **186**
 Utility stitches _____ 186
 Character sewing _____ 186
 Character embroidering chart _____ 190
 Frame pattern embroidering chart _____ 190

PATTERNS (MEMORY CARD)

_____ **191**
 One point mark embroidery pattern _____ 191

*MY CUSTOM STITCH™ is under application for a registered trademark in the United States of America.

PRINCIPAL PARTS

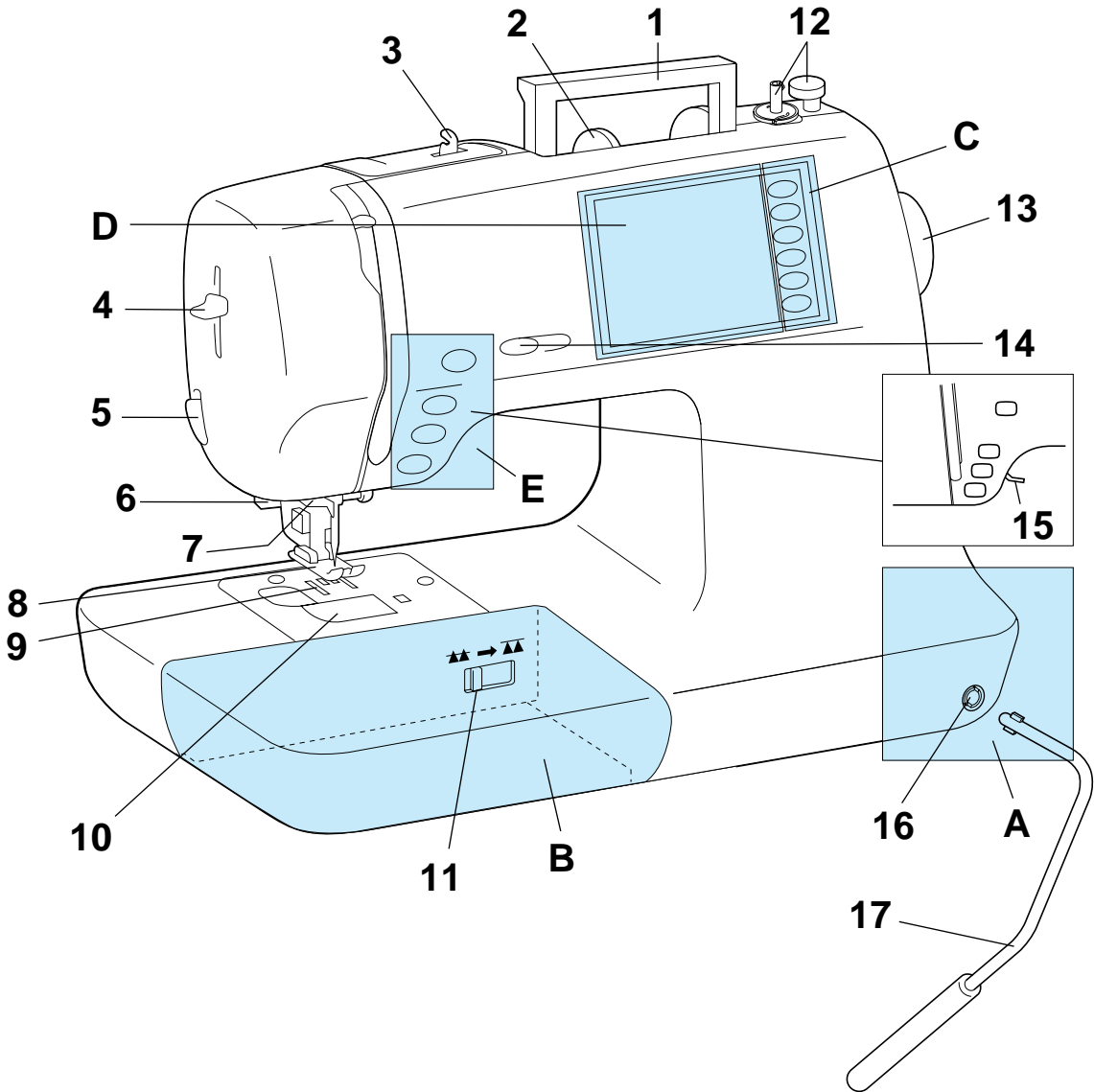

- 1- Handle
- 2- Spool cap
- 3- Thread guide for bobbin winding
- 4- Needle threader lever
- 5- Thread cutter
- 6- Buttonhole lever
- 7- Needle threader
- 8- Presser foot
- 9- Feed dog
- 10- Bobbin cover
- 11- Feed dog adjustment lever
- 12- Bobbin winder device
- 13- Balance wheel
- 14- Speed range control lever
- 15- Presser foot lever
- 16- Knee Lifter Mounting Slot
- 17- Knee Lifter

- A- Main power switch and connectors
- B- Accessory compartment
- C- Selection keys (Refer to page 10)
- D- L.C.D. (Liquid Crystal Display)
- E- Operation buttons (Refer to page 11)

Setting Up

Sewing

Utility Stitches

Characters and Decorative Stitches

Embroidering

Editing Embroidery Patterns

Retrieving

My Custom Stitch™

Maintenance

Error Messages

Trouble shooting

Sewing Chart

Patterns (Programmed in Machine)

Patterns (Memory Card)

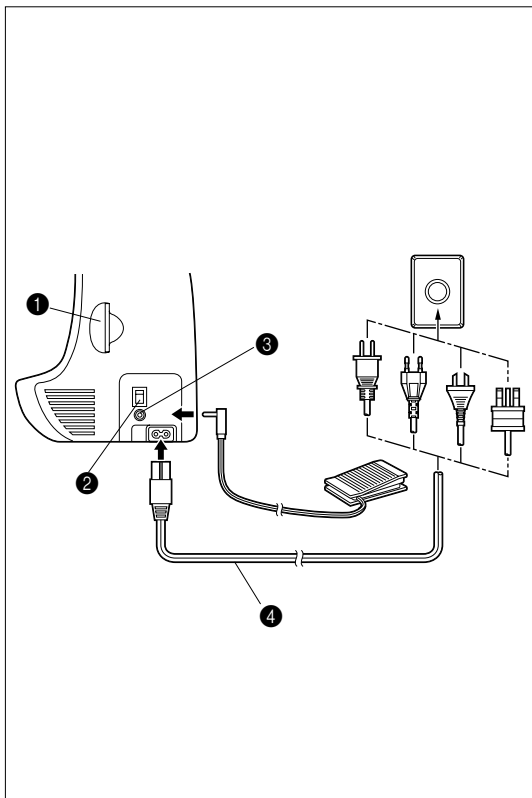

A. MAIN POWER SWITCH AND CONNECTORS

- ① **Card slot**
Slot for memory card insertion.
- ② **Main power switch**
Use to turn on/off the main power.
- ③ **Controller jack**
Insert for foot controller operation.
- ④ **Power cord**
Use to connect machine to power supply.

CAUTION

- When leaving the machine unattended, the main switch of the machine must be switched off or the plug must be removed from the socket-outlet.
- When servicing the machine, or when removing covers or changing bulbs, the machine or the electrical set must be unplugged.
- For U.S.A. only
This appliance has a polarized plug (one blade wider than the other). To reduce the risk of electric shock, this plug is intended to fit in a polarized outlet only one way. If the plug does not fit fully in the outlet, reverse the plug. If it still does not fit, contact a qualified electrician to install the proper outlet. Do not modify the plug in any way.

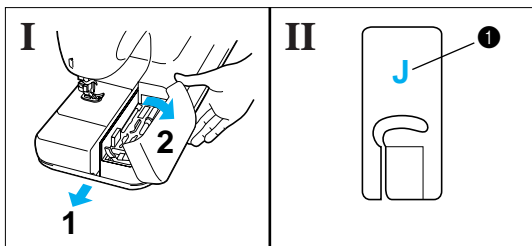

B. FLAT BED ATTACHMENT WITH ACCESSORY COMPARTMENT

- I Tilt the lid of the accessory compartment toward you to open.
- II Each presser foot has a symbol.
- ① Presser foot symbol

III ACCESSORY LIST

The location of each accessory is shown in figure III.

| No. | Part Name | Part Code |
|-----|-------------------------|------------|
| ① | Buttonhole foot "A" | X57789-101 |
| ② | Embroidery foot "Q" | XA5891-101 |
| ③ | Overcasting foot "G" | X51162-001 |
| ④ | Monogramming foot "N" | X53840-301 |
| ⑤ | Zipper foot "I" | X59370-051 |
| ⑥ | Zigzag foot "J" | 137748-101 |
| ⑦ | Blind stitch foot "R" | X56409-001 |
| ⑧ | Seam ripper | X54243-001 |
| ⑨ | Button fitting foot "M" | 130489-001 |
| ⑩ | Bobbin | 136492-101 |
| ⑪ | Needle set | X58358-001 |

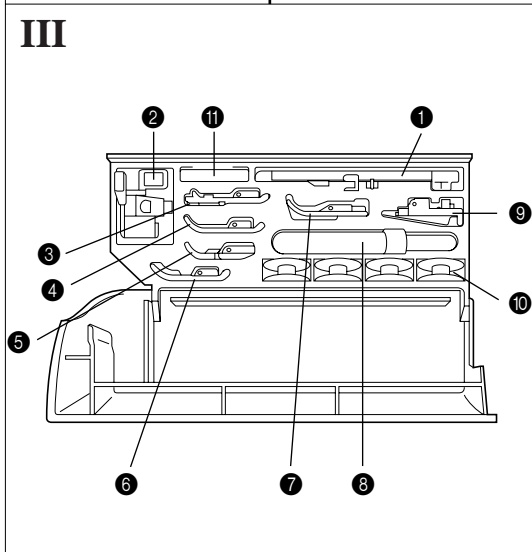

- * Always use the plastic bobbin which is supplied with machine or in accessory compartment.
- * Always use BROTHER accessories recommended for this machine.

OTHER INCLUDED ACCESSORIES

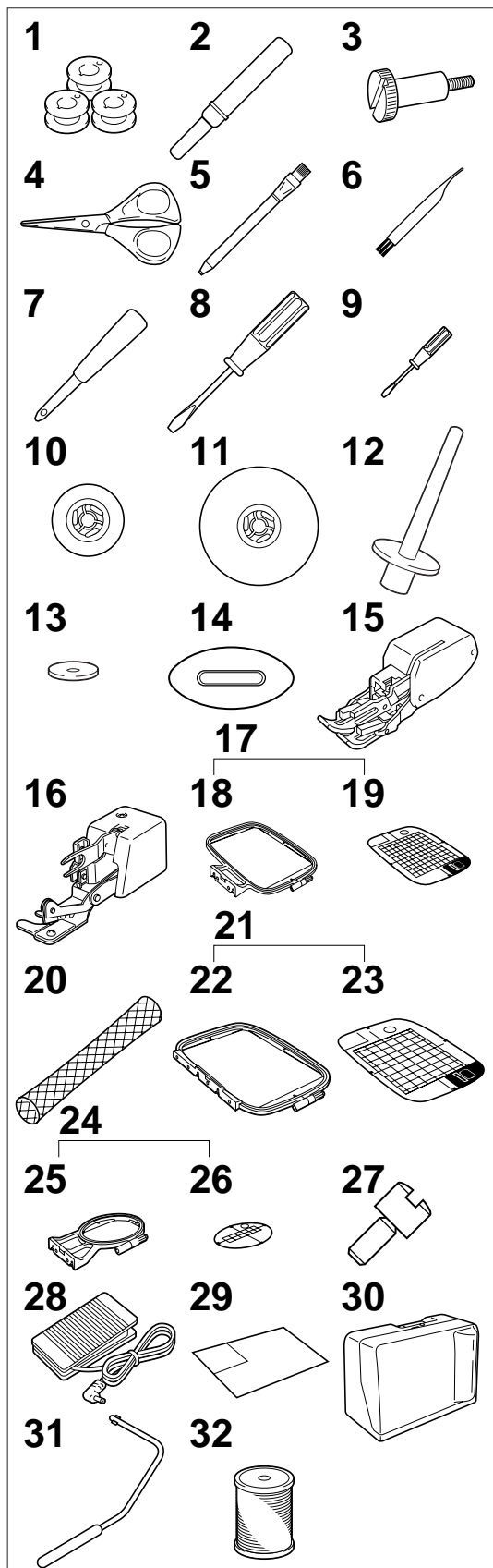

| No. | Part Name | Part Code | |
|-----|----------------------------|------------|------------|
| | | U.S.A. | Others |
| 1 | Bobbin (3) | 136492-101 | |
| 2 | Seam ripper | X54243-001 | |
| 3 | Screw | XA5904-051 | |
| 4 | Scissors | 184783-001 | |
| 5 | Chalk pen | 184944-001 | |
| 6 | Cleaning brush | XA4527-001 | |
| 7 | Eyelet punch | 135793-001 | |
| 8 | Screwdriver (Large) | X55467-051 | |
| 9 | Screwdriver (Small) | X55468-051 | |
| 10 | Spool cap (Small) | 130013-003 | |
| 11 | Spool cap (Large) | 130012-003 | |
| 12 | Extra spool pin* | XA3336-051 | |
| 13 | Spool felt | X57045-001 | |
| 14 | Disc-shaped screwdriver | XA2005-051 | |
| 15 | Walking foot* | X81064-001 | |
| 16 | Side cutter | X80943-001 | |
| 17 | Embroidery set (Regular) | SA422 | X80903-002 |
| 18 | Embroidery frame (Regular) | XA2171-101 | |
| 19 | Embroidery sheet (Regular) | XA2212-001 | |
| 20 | Net* | 127610-000 | |
| 21 | Embroidery set (Large) | SA423 | X80902-002 |
| 22 | Embroidery frame (Large) | XA2168-201 | |
| 23 | Embroidery sheet (Large) | XA2209-001 | |
| 24 | Embroidery set (Small) | SA421 | X80904-102 |
| 25 | Embroidery frame (Small) | XA2174-101 | |
| 26 | Embroidery sheet (Small) | XA2215-101 | |
| 27 | Screw* | XA4813-051 | |
| 28 | Foot controller | 234522-001 | |
| 29 | Pattern Sheet | XA4595-001 | |
| 30 | Hard case | XA1821-106 | |
| 31 | Knee Lifter | XA6941-001 | |
| 32 | Embroidery bobbin thread | SA-BTS | X81164-001 |

- * Use the same screw when installing both the side cutter and the walking foot.
- * If using special threads which wind quickly off the thread spool, place a net on the spool before using.
- * If using the walking foot, please refer to the explanatory sheet which is inserted in the instruction book.
- * The extra spool pin which is provided as an accessory should be attached to the end of the bobbin winder shaft during use.

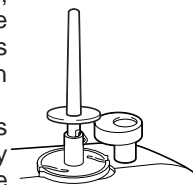

Note (For U.S.A. only)

Foot controller: Model J2
This foot controller can be used for this machine model PC-8500.

OPTIONS

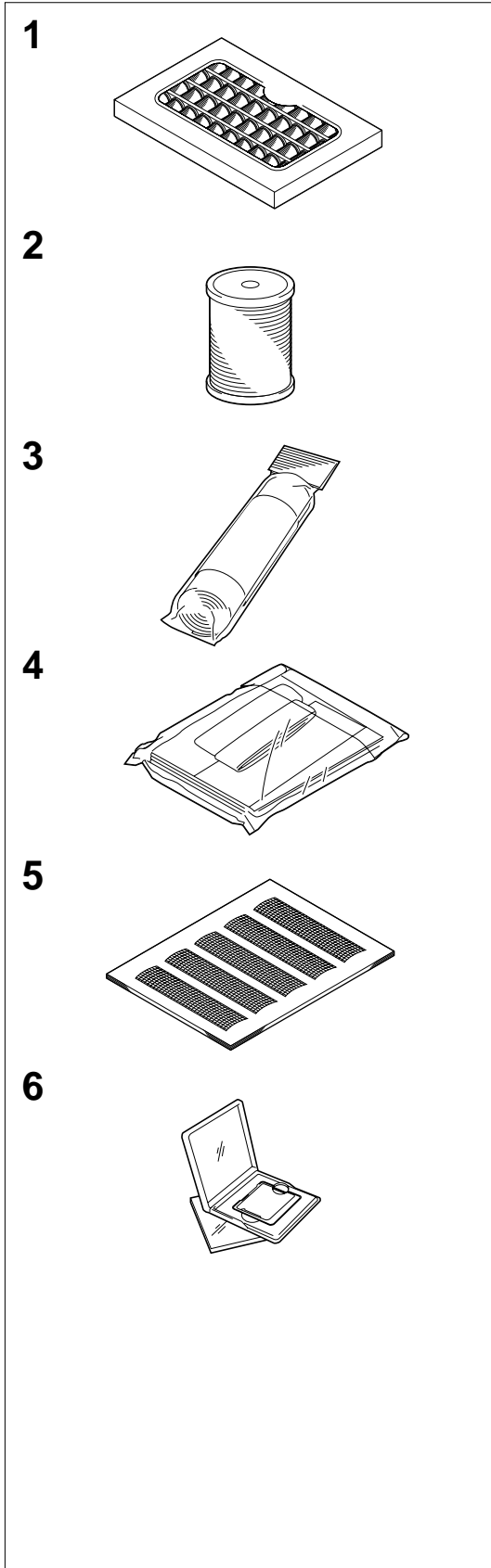

| No. | Part Name | Part Code | |
|-----|--|-----------|------------|
| | | U.S.A. | Others |
| 1 | Brother poly 40 color thread set | SA740 | X80928-100 |
| 2 | Brother poly #60 bobbin thread | SA-BTS | X81164-001 |
| 3 | Backing material (Stabilizer material) | SA519 | X81185-001 |
| 4 | Country bag | SA152 | X80922-002 |
| 5 | Grid sheet set | SA500 | X80948-001 |
| 6 | Memory card* | | |
| | No. 1 Alphabet | SA298 | X58317-001 |
| | No. 2 Flower | SA299 | X58321-001 |
| | No. 3 Dinosaur | SA300 | X58362-001 |
| | No. 6 Moskowitz's World | SA303 | X58497-001 |
| | No. 7 Country Life | SA304 | X59322-001 |
| | No. 8 Holiday | SA305 | X59357-001 |
| | No. 9 Hobby Craft | SA306 | X59511-001 |
| | No. 10 Monogram Emblem | SA307 | X59567-001 |
| | No. 11 Frame | SA311 | XA0257-001 |
| | No. 12 Transportation | SA312 | XA0275-001 |
| | No. 13 Sports Emblem | SA313 | XA0517-001 |
| | No. 14 Large Floral | SA314 | XA1223-001 |
| | No. 15 Cute Kids | SA315 | XA1325001 |
| | No. 16 Dogs & Cats | SA316 | XA1406-001 |
| | No. 17 Nintendo | SA317 | XA1434-001 |
| | No. 19 Marine | SA319 | XA2452-001 |
| | No. 20 Petite Designs | SA320 | XA2869-001 |
| | No. 21 Needlework | SA321 | XA2873-001 |
| | No. 26 Snoopy | SA326 | XA3826001 |
| | No. 27 Birds | SA327 | XA4289001 |
| | No. 28 Christmas | SA328 | XA4502001 |
| | No. 29 Lace | SA329 | XA4664001 |
| | No. 30 Wildlife animals | SA330 | XA4771001 |
| | No. 31 Large flower II | SA331 | XA5037001 |
| | No. 32 Musical instrument | SA332 | XA5386001 |
| | No. 33 Trees | SA333 | XA5567001 |
| | No. 35 Cats & dogs II | SA335 | XA5629001 |
| | No. 36 Fruits & vegetables | SA336 | XA5659001 |
| | No. 37 Applique alphabet | SA337 | XA5753001 |
| | No. 38 Angel | SA338 | XA5781001 |
| | No. 39 Doll face | SA339 | XA5978001 |
| | No. 40 Sports 3 | SA340 | XA6111001 |

* This unit cannot be used in conjunction with the memory card S-1.

WARNING

- Embroidery Card purchased in foreign countries may not work with your machine.

POWER SUPPLY

WARNING

- When leaving the machine unattended or when it is not being used, turn off the main power switch of the machine or remove the plug from the wall outlet.

CAUTION

- Do not use this sewing machine with extension cords or multi-plug adaptors, otherwise a fire or an electric shock may occur.
- Do not remove the plug from the wall outlet with wet hands, otherwise an electric shock may occur.
- When unplugging the power cord, turn off the main power switch of the machine, then grasp the plug and pull to unplug the cord. Pulling on the cord may damage it or cause a fire or an electric shock.
- Do not allow the power cord to be cut, damaged, modified, forcefully bent, pulled, twisted or bundled. In addition, do not place heavy objects on the cord or subject it to heat, otherwise the cord may be damaged or a fire or an electric shock may occur. If the power cord or plug are damaged, contact your nearest authorized Brother dealer or service center.
- If the machine is not to be used for a long period of time, unplug the power cord, otherwise a fire may occur.

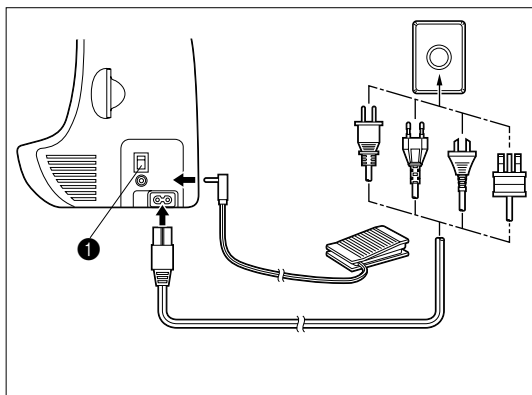

1. Insert the plug into a wall outlet.

① Main power switch

2. Set the main power switch to “ I ”.
3. To turn off the machine, set the main power switch to “ O ”.

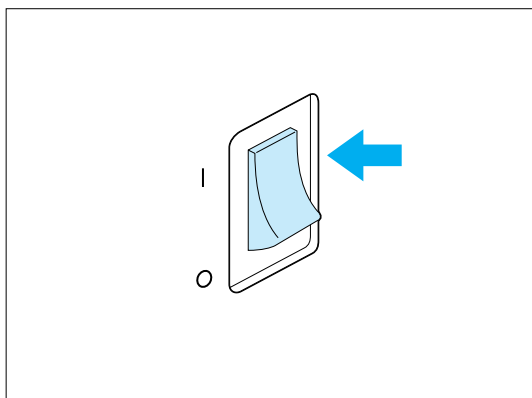

SELECTION KEYS

Screen messages guide you through each operation

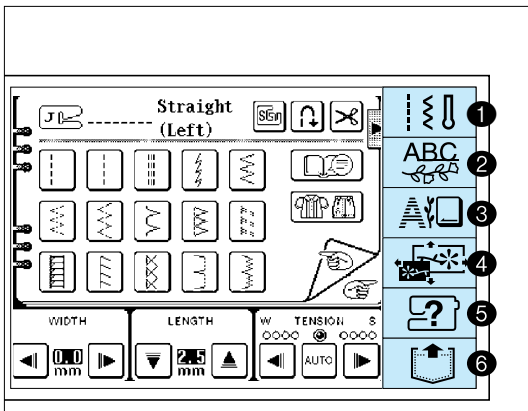
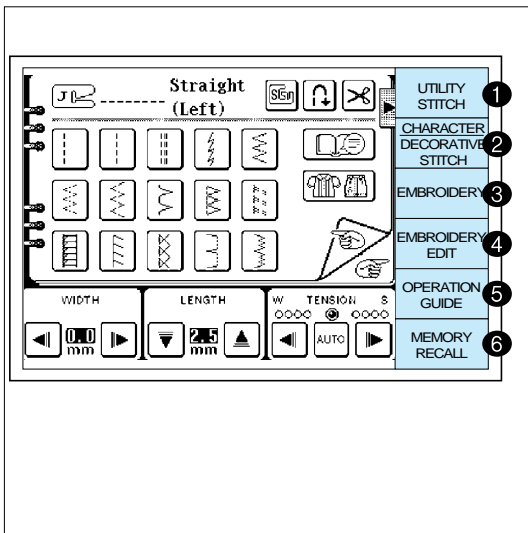

C. SELECTION KEYS

* Depending on the country of destination, the selection keys may be displayed by means of characters or by illustrations.

- ① **“UTILITY STITCH” KEY**
Use this key when you sew utility stitches such as straight stitches, buttonholes, etc.
- ② **“CHARACTER/DECORATIVE STITCH” KEY**
Use this key to sew alphabetical characters and other decorative stitches.
- ③ **“EMBROIDERY” KEY**
Use this key when using a memory card and when embroidering pre-programmed patterns. When you insert or remove the memory card from the machine, the main power switch should always be turned off.
- ④ **“EMBROIDERY EDIT” KEY**
Use this key for embroidering patterns which are combinations of other patterns.
- ⑤ **“OPERATION GUIDE” KEY**
Use this key if you would like information on how to use machine functions such as upper threading, bobbin winding and bobbin thread setting.
- ⑥ **“MEMORY RECALL” KEY**
Use this key to retrieve combined patterns which have been saved in memory.

OPERATION BUTTONS

Using the operation buttons

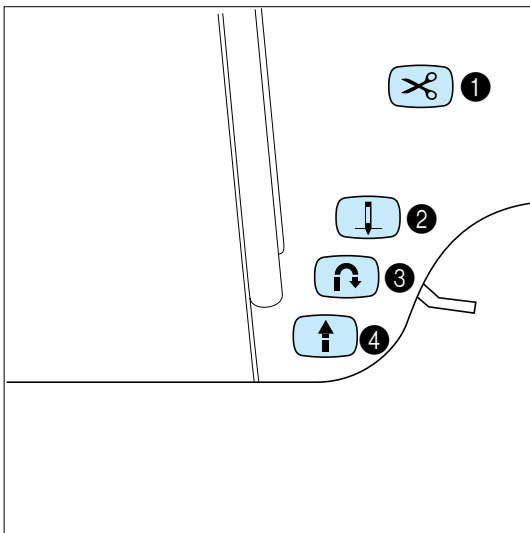
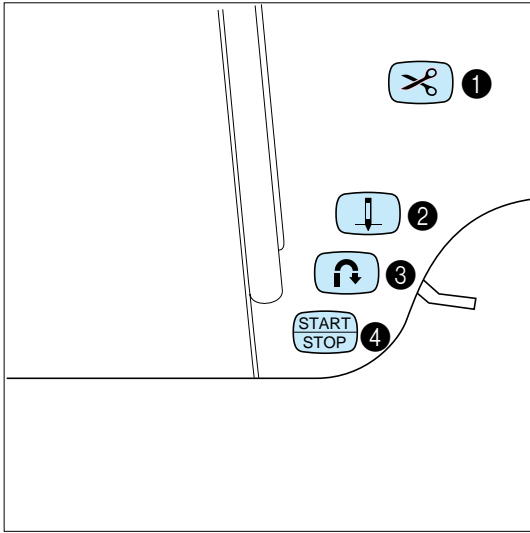

D. OPERATION BUTTONS

- ❶ **“THREAD CUTTER” BUTTON**
When you press this button, both upper and bobbin threads are cut automatically.
 - ❷ **“NEEDLE POSITION” BUTTON**
Press to change the needle position from up to down or from down to up.
 - ❸ **“REVERSE STITCH” BUTTON**
The reverse stitch button is used to secure and end stitching with a reverse stitch or reinforcement stitch. The reverse stitch function stitches backward. The reinforcement stitch function stitches three times in the same position. (See page 38 for full instructions.)
 - ❹ **“START/STOP” BUTTON**
The button illuminates green when the machine is ready to be started and while sewing or embroidering. If starting is not possible, it illuminates red. In addition, it illuminates orange when the bobbin thread is being wound onto the bobbin (when the bobbin winder shaft is to the right).
- * Sewing continues at low speed while the button is pressed.
 - * The needle will drop to its lowest position when the machine is stopped.

Setting Up

Sewing

Utility Stitches

Characters and Decorative Stitches

Embroidering

Editing Embroidery Patterns

Retrieving

My Custom Stitch™

Maintenance

Error Messages

Trouble shooting

Sewing Chart

Patterns (Programmed in Machine)

Patterns (Memory Card)

USING THE SCREEN KEYS

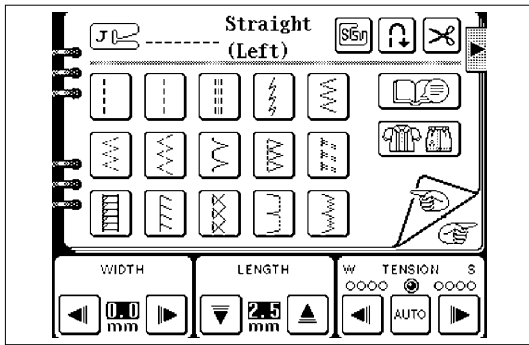

Touch a key on the screen with your finger to select the pattern which appears inside the key or to start the function or operation indicated inside the key.

CAUTION

Be sure to touch the key with your finger only. Never use a pointed instrument such as a sharp pencil or a screwdriver or a hard object to touch the key.

Furthermore, do not press down too hard on the screen, otherwise problems may result.

Examples of the keys on LCD

“”:

Touch this key to return to the previous page.

“”:

Touch this key to move to the next page.

“CHECK”:

If an error message appears, touch this to return to the original screen.

“CLOSE”:

If another screen is being displayed over the top of an advice screen, for example, touch this key to remove the topmost screen.

“RETURN”:

Touch this key to return to the previous screen.

“END”:

Touch this key to stop using the function.

“CONFIRM”:

Touch this key to start a function working.

About the screen

NOTES

- All or parts of the screen may become darker or lighter at times because of changes in the ambient temperature around the screen. This is normal and is not the sign of a malfunction. Adjust the screen if it is difficult to read.
- The screen may be dark, immediately after the power is turned on. This is a feature of the light which illuminates the screen, and is not the sign of a malfunction. The screen will return to its normal level of brightness after approximately 10 minutes.

If the LCD is hard to see when the power is turned on

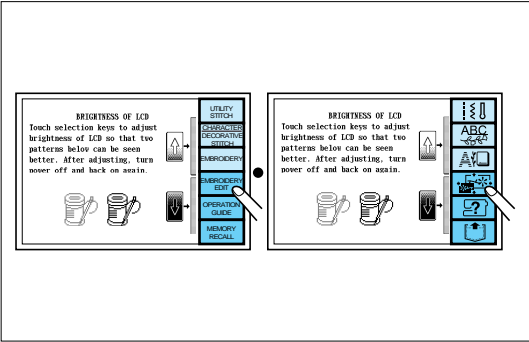
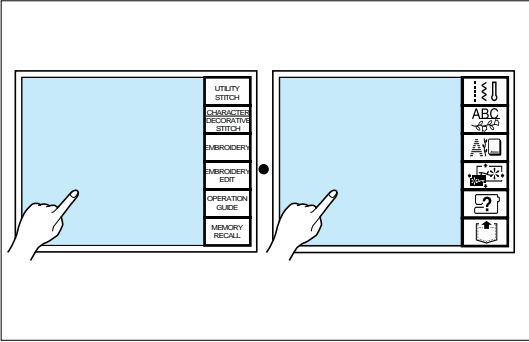

1. While touching the LCD (anywhere is OK), turn the power off and then back on again.

* The START/STOP button will not illuminate at this time.

2. Touch any one of the lower three selection keys (EMBROIDERY EDIT, OPERATION GUIDE or MEMORY RECALL). The LCD will become darker each time one of these keys is touched. If you would like to make the LCD lighter, touch any one of the upper three selection keys (UTILITY STITCH, CHARACTER/DECORATIVE STITCH or EMBROIDERY).

3. After you have finished adjusting, turn the power off and back on again once more.

Adjusting the brightness of the LCD.

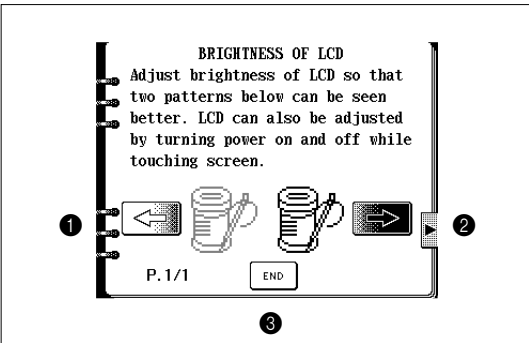
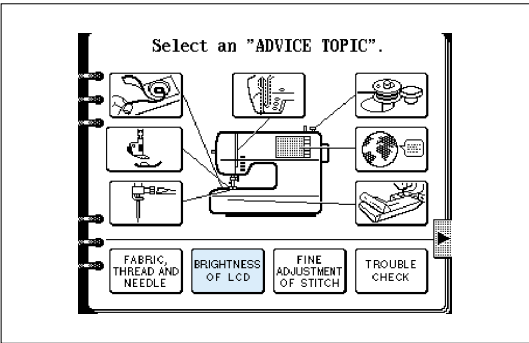



1. Touch the "OPERATION GUIDE" key.
2. Touch the "BRIGHTNESS OF LCD" key.

- 1 Touch this key to make contrast less (lighter).
- 2 Touch this key to make contrast greater (darker).
- 3 Touch this key to return to the screen which was previously being displayed.

HOW TO USE THE LANGUAGE SELECTION KEY

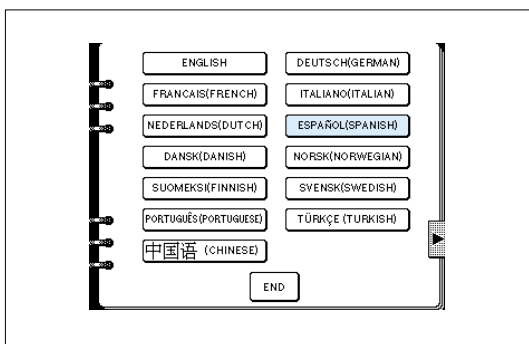
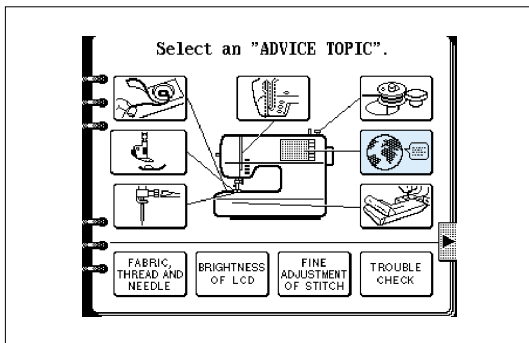
You can use the “” key to easily change the display language for all the keys and messages on the LCD screen to the language you need.



1. Touch the "OPERATION GUIDE" key.
2. Touch the “” key.
3. The language display screen will then appear. Touch the key which corresponds to the desired language.

Example: To change the display language to Spanish

1. Touch the “” key.
2. Touch "ESPAÑOL (SPANISH)". This will change the language setting to Spanish.
3. The display will then return to the screen which was previously being displayed.

Note

- * When the “” key is used to set the display language, error messages will also be displayed in the language selected.
- * The display language can be selected from a list of 13 languages (English, German, French, Italian, Dutch, Spanish, Danish, Norwegian, Finnish, Swedish, Portuguese, Turkish and Chinese).

How to clear the language selection

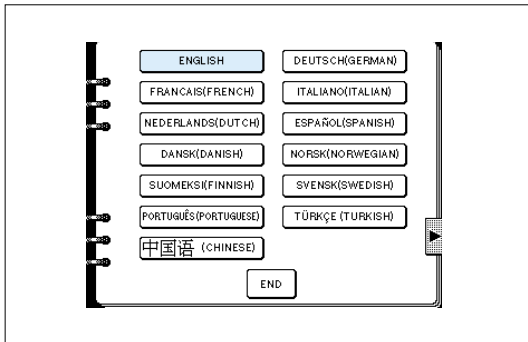

Example: To change the display language from Spanish back to English

1. Touch the “OPERATION GUIDE” key.
2. Touch the “ ” key.
3. Touch the “ENGLISH” key.
This will cancel the Spanish language setting and return all screen displays and error messages to the English language.

CAUTION

- This function should not be used as a translation function.
- If the power supply is turned off, the current language setting will be retained and will not be cleared.

BOBBIN WINDING / BOBBIN THREAD SETTING

Winding the bobbin and setting the bobbin thread

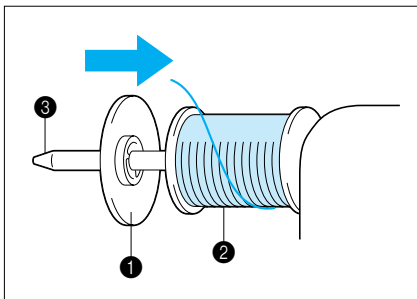
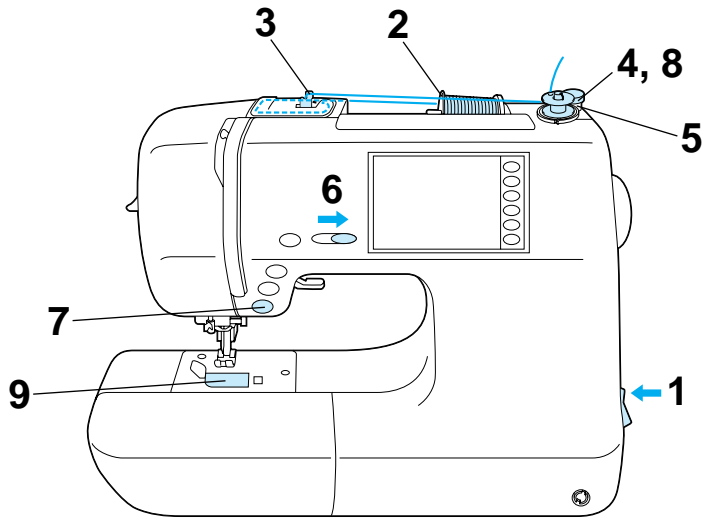

1. Connect the machine to the power supply and turn on the main power.
2. Place the spool of thread on the spool pin. The thread end should come from the bottom front of the spool. The spool cap closest to the thread spool size should be used to hold the spool securely on the spool pin.

- ① Spool cap
- ② Spool
- ③ Spool pin

* The spool cap should be pushed on as far as it will go.

Note

If using a fine thread such as cross wound thread, slightly separate the spool cap (small) from the spool of thread before using it.

- ① Cross wound thread
- ② Spool cap (small)
- ③ Gap

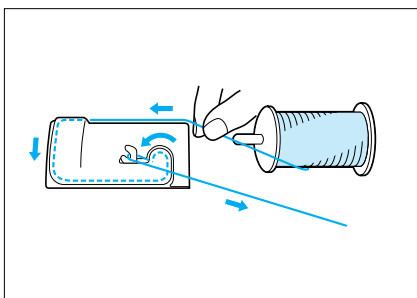
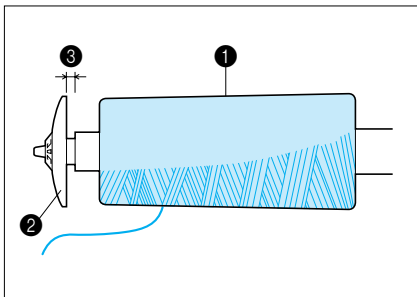

3. Steady the spool thread in your right hand, take the end of the thread in your left hand, and pass it through the guides in the order shown by the numbers.

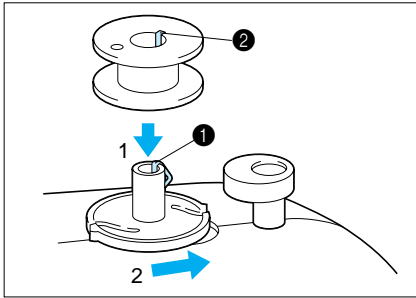

4. Align the groove in the bobbin with the spring on the shaft and place the bobbin on the bobbin winder shaft. Then, push the bobbin winder shaft to the right.

- ❶ Spring on the shaft
- ❷ Groove of the bobbin

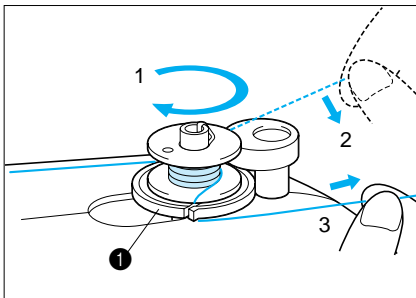

5. Wind the thread clockwise around the bobbin four or five times, pass the end of the thread through the slit in the bobbin winder seat, and then pull the thread in the direction shown in the illustration. Use the cutter to cut the thread.

- ❶ Bobbin winder seat

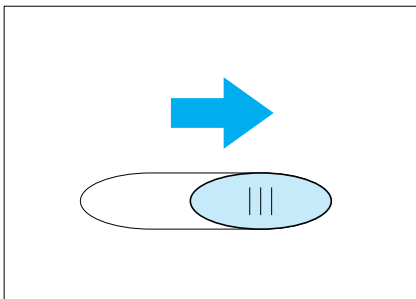

- 6. Slide the speed range control lever to its maximum (as far to the right as possible).
- 7. Press the “START/STOP” button. The machine will stop automatically when the bobbin is full.
- 8. After the bobbin has stopped moving, press the “START/STOP” button to stop the machine.
- 9. Cut the thread, slide the bobbin winder shaft to the left and remove the bobbin.

Setting the bobbin

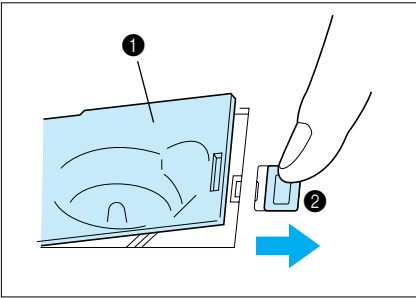

1. Slide open the bobbin cover.

- ❶ Bobbin cover
- ❷ Bobbin cover release button

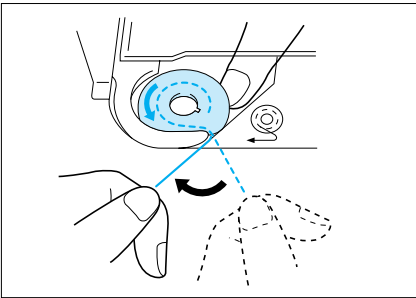

2. Insert the bobbin into the shuttle with the thread direction as noted in the diagram.

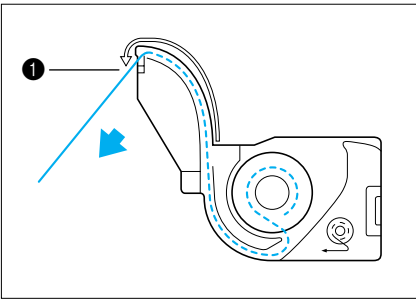

3. Guide the thread end through the slit, then pull the thread toward you to cut off any excess thread.

- ❶ Built-in thread cutter

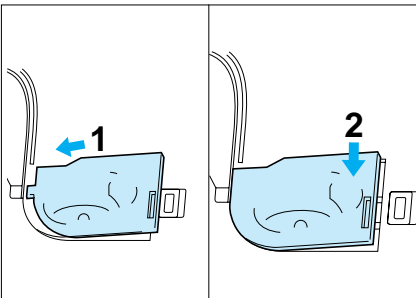

4. Close the bobbin cover by placing the left end in place and pressing down lightly on the right end so that it snaps into place.

* Sewing can begin without pulling out the bobbin thread.

UPPER THREADING

Thread according to number and arrow marks on machine.

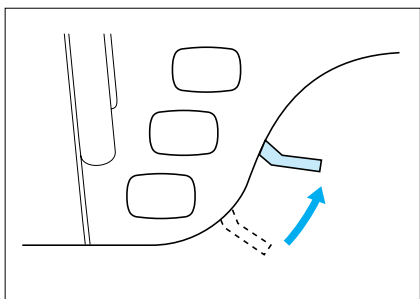
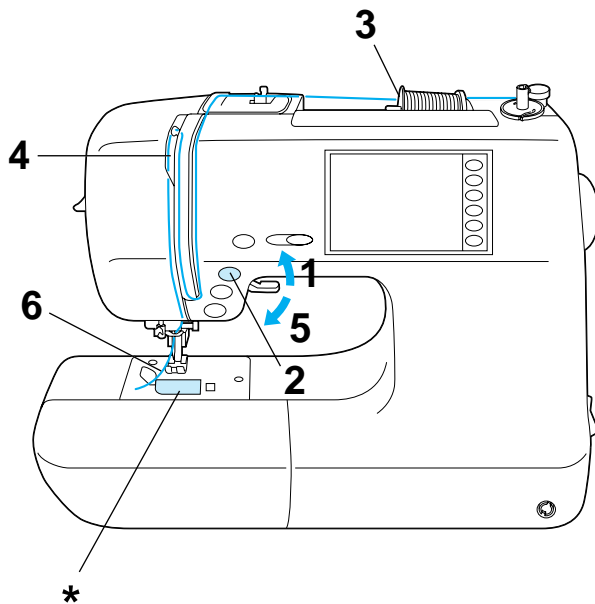

1. Raise the presser foot lever. (If the presser foot is not raised, the upper thread cannot be threaded.)

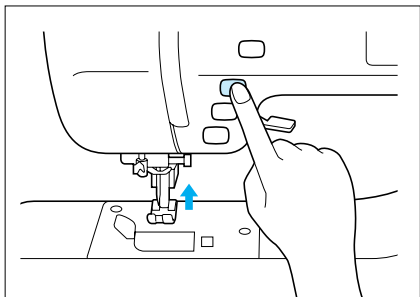

2. Press the "NEEDLE POSITION" button to raise the needle to the up position.

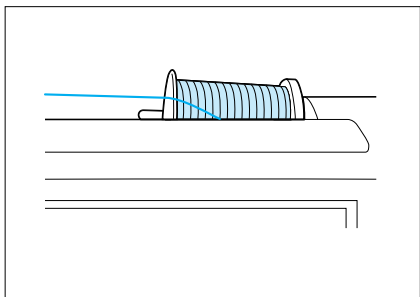

3. Set the thread spool. The thread end should come from the bottom front of the spool. The spool cap closest to the thread spool size should be used to hold the spool securely on the spool post.

Insert the thread firmly to the bottom of the guide.

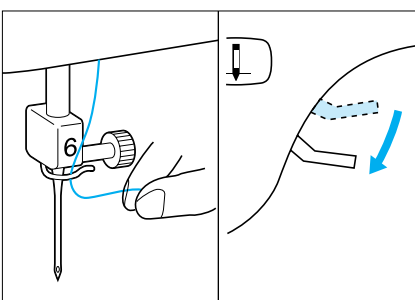
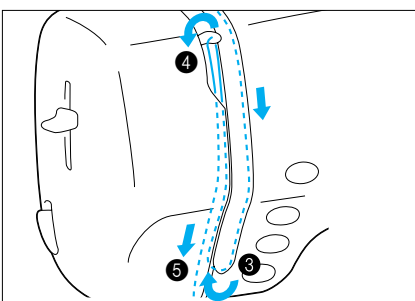
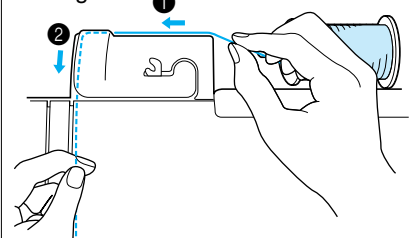

- Steady the spool thread in your right hand, take the end of the thread in your left hand, and keep it taut while passing it through the guides in the order shown by the numbers.

Note

Incorrect threading may cause damage.

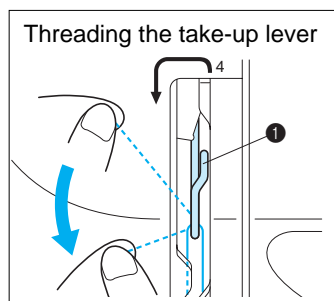

- Thread take-up lever

- Lower the presser foot.
- Thread the needle manually or using the auto-threading device.
- * You do not need to pull the bobbin thread up before you start sewing.
- Pass the thread underneath the presser foot and pull it out from the rear of the machine by about 5 cm.

Note

Always raise the presser foot before removing the upper thread from the machine or damage may occur to the auto thread tension unit.

Auto-threading device

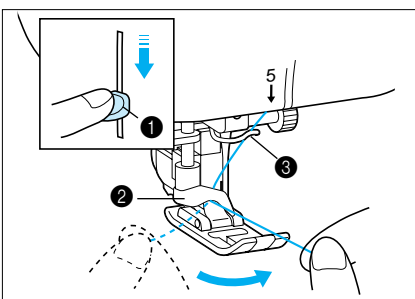

- Guide the thread through the wire loop and gently pull the thread towards you.

- Needle threader lever
- Guide (Large hook)
- Wire loop

- * Lowering the presser foot will engage the automatic tension and will allow you to grip the thread as you proceed.

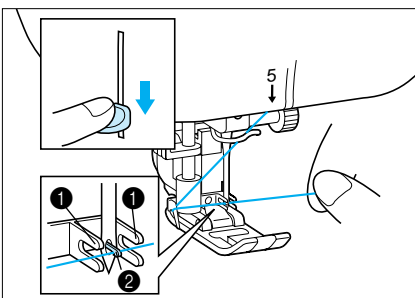

- Lower the needle threader lever all the way down using your left index finger. Check that the thread is held by the guide (large hook) and that the hook on the needle threader has passed through the eye of the needle.

- Second set of hooks
- Third hook

- As you lower the needle threader lever drape the thread to the left and the large hook will catch the thread. When the needle threader lever is in the lowest position, drape the thread across the eye of the needle.

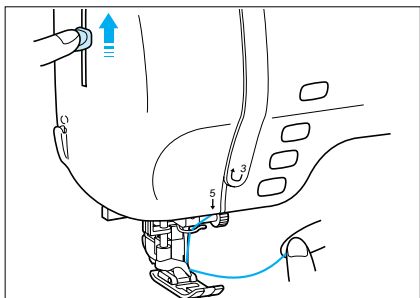

* Rotating your right hand slightly to check that the thread is engaged.

4. While gently holding the thread, raise the needle threader lever.

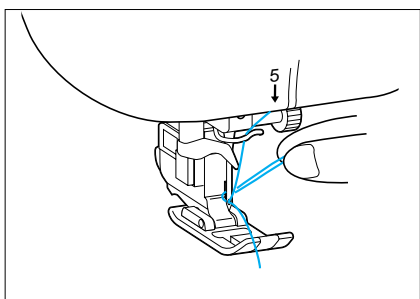

5. Pull the thread towards the rear to finish the upper threading.

6. Pass the thread underneath the presser foot and pull it out from the rear of the machine by about 5 cm (1-15/16").

Using the extra spool pin and the net

Extra spool pin

Use when embroidering with metallic thread.

1. Insert the extra spool pin into the end of the bobbin winder shaft.
2. Install the spool felt and the thread spool in that order, and then thread the upper thread.

① Insert the extra spool pin into the end of the bobbin winder shaft

② Spool felt

③ Thread spool

* When setting the thread spool, set it so that the thread winds off from the front of the spool.

* If using metallic thread, we recommend that you use a 90/14 home sewing machine needle.

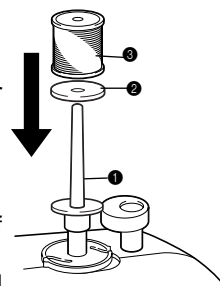

Note

This method keeps the thread from twisting as it comes off the spool pin.

Net

If using special threads which wind quickly off the thread spool, attach a net to the spool before using.

* Cut the net to match the size of the spool.

① Net

② Thread spool

③ Spool pin

④ Spool cap

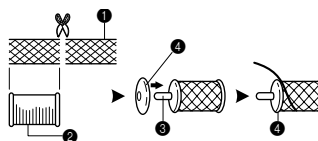

Note

The auto-threading device cannot be used with the combinations shown at left.

Transparent nylon thread can be used regardless of the chart providing needle used in 90/14 to 100/16.

| Needle | Thread (cotton) |
|--------|-----------------|
| 65/9 | #30, 50, 60 |
| 75/11 | #30 |
| 90/14 | #30 |
| 100/16 | #20 |

START/STOP

“START/STOP” button

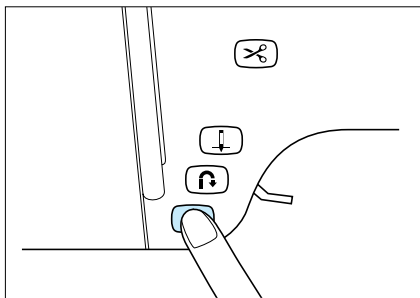

- 1 Place the fabric under the presser foot, lower the presser foot, and then press the “START/STOP” button. This machine starts sewing.
- * Hold down the “START/STOP” button to sew at a slow speed.
2. Press the “START/STOP” button to stop this machine.

Foot controller

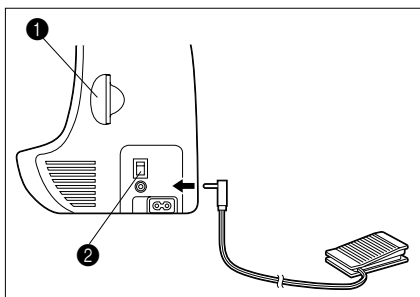

Note

Do not allow fabric pieces and dust to collect in the foot controller. Doing so could cause a fire or an electric shock.

1. With this machine turned off, insert the foot controller plug into its jack on this machine.

- ① Foot controller
- ② Foot controller jack

2. Turn on this machine, then slowly depress the foot controller to start sewing.

* The speed set using the speed range control lever is the foot controller's maximum sewing speed.

3. Release the foot controller to stop this machine.

* When the foot controller is being used, the “START/STOP” button has no effect on the sewing.

Note (For U.S.A. only)

Foot controller: Model J2

This foot controller can be used for this machine model PC-8500.

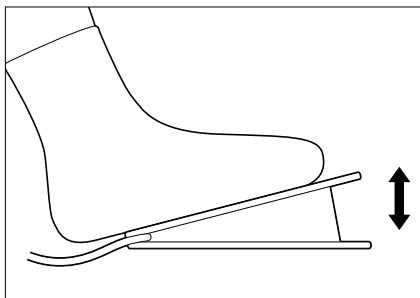

Mounting and Using the Knee Lifter

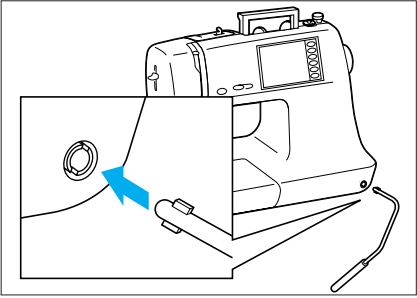

Align the knee lifter with the mounting slot and insert.

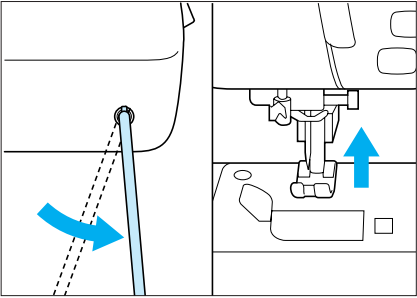

Use your knee to raise the knee lifter to the right in order to free both your hands for other tasks.

STITCH WIDTH AND STITCH LENGTH

Stitch width

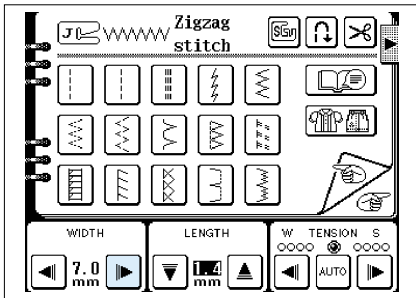

Increasing the stitch width

Touch the “▶” stitch width setting key.

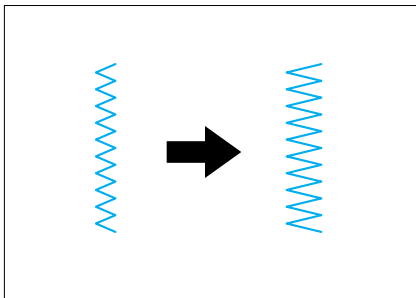

The stitch width setting value will increase each time you touch the key.

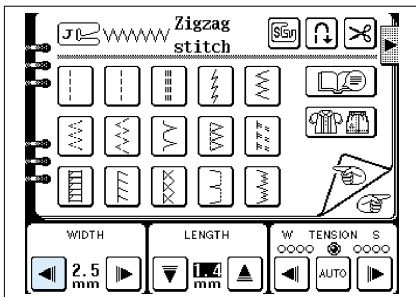

Decreasing the stitch width

Touch the “◀” stitch width setting key.

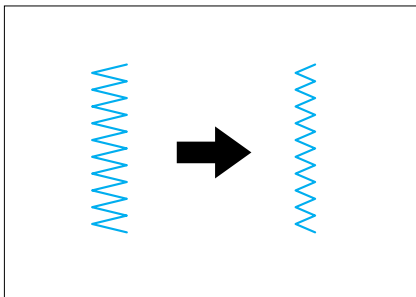

The stitch width setting value will decrease each time you touch the key.

Setting Up

Sewing

Utility Stitches

Characters and Decorative Stitches

Embroidering

Editing Embroidery Patterns

Retrieving

My Custom Stitch™

Maintenance

Error Messages

Trouble shooting

Sewing Chart

Patterns (Programmed in Machine)

Patterns (Memory Card)

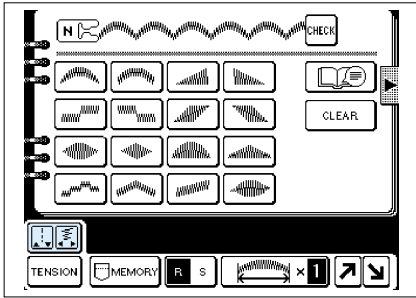

Sewing characters and patterns using satin stitches

Touch the “CHARACTER/DECORATIVE STITCH” key from the selection keys in the right side of the machine. Touch the “” key on the LCD screen.

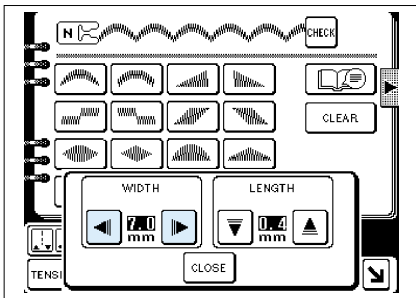

* If you touch the “CLOSE” key, the display will return to the previous screen.

Stitch length

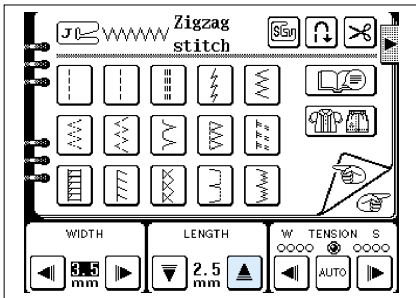

Increasing the stitch length

Touch the “” stitch length setting key.

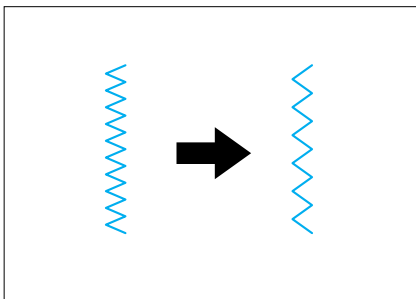

The stitch length setting value will increase each time you touch the key.

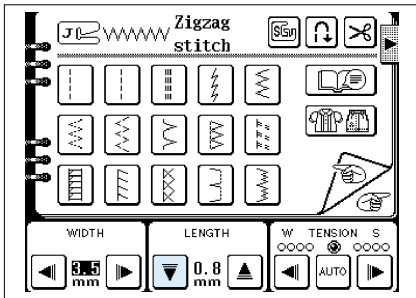

Decreasing the stitch length

Touch the “” stitch length setting key.

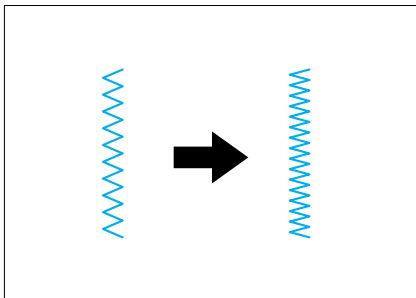

The stitch length setting value will decrease each time you touch the key.

- * When sewing straight stitches, if the fabric thickness is less than 1 mm, the stitch length is automatically changed to 4.0 mm at the sewing start to prevent gathering, even if you set the length to 5.0 mm.

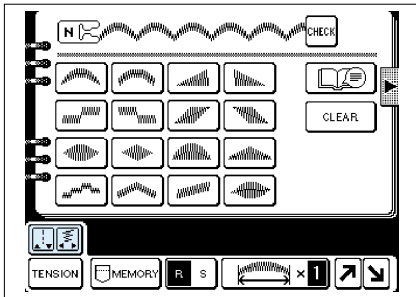





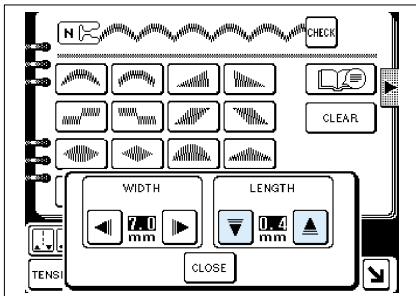



































Sewing characters and patterns using satin stitches





















Press the “CHARACTER/DECORATIVE STITCH” key from the selection keys on the right side of the machine. Touch the “” key to adjust.



- * If you touch the “CLOSE” key, the display will return to the previous screen.

Quick adjustment reference chart for stitch width and stitch length

| STITCH | | Stitch width [mm (inch.)] | | Stitch length [mm (inch.)] | | STITCH | | Stitch width [mm (inch.)] | | Stitch length [mm (inch.)] | | |
|-----------------|---|---|---------------------|----------------------------|---------------------|---|---|---|------------------------|----------------------------|------------------------|---|
| | | Auto. | Manual | Auto. | Manual | | | Auto. | Manual | Auto. | Manual | |
| Straight (Left) |  | [0.0 (0.0)] | 0.0–7.0 (0–1/4) | 2.5 (3/32) | 0.2–5.0 (1/64–3/16) |  |  | 7.0 (1/4) | 3.0–7.0 (1/8–1/4) | 0.5 (1/32) | 0.3–1.0 (1/64–1/16) | |
| | Straight (Middle) |  | – | – | 2.5 (3/32) | | | | | | | 0.2–5.0 (1/64–3/16) |
| Stretch stitch |  | [0.0 (0.0)] | 0.0–7.0 (0–1/4) | 2.5 (3/32) | 1.5–2.5 (1/16–3/32) |  |  | 7.0 (1/4) | 2.5–7.0 (3/32–1/4) | 2.0 (1/16) | 0.4–2.5 (1/64–1/16) | |
| | |  | 1.0 (1/16) | 1.0–3.0 (1/16–1/8) | 2.5 (3/32) | | | | | | | 1.0–4.0 (1/16–3/16) |
| Zigzag |  | 3.5 (1/8) | 0.0–7.0 (0–1/4) | 1.4 (1/16) | 0.0–4.0 (0–3/16) | Darning |  | 7.0 (1/4) | 2.5–7.0 (3/32–1/4) | 2.0 (1/16) | 0.4–2.5 (1/64–1/16) | |
| Elastic zigzag |  | 5.0 (3/16) | 1.5–7.0 (1/16–1/4) | 1.0 (1/16) | 0.2–4.0 (1/64–1/16) | | Bar tack | | | | |  |
| | |  | 5.0 (3/16) | 1.5–7.0 (1/16–1/4) | 1.0 (1/16) | 0.2–4.0 (1/64–1/16) | Tape attaching |  | 4.0 (3/16) | 0.0–7.0 (0.0–1/4) | 1.0 (1/16) | 0.2–4.0 (1/61–3/16) |
| Overcasting |  | 3.5 (1/8) | 2.5–5.0 (3/32–3/16) | 2.0 (1/16) | 1.0–4.0 (1/16–3/16) | Eyelet |  | 7.0 (1/4) | 7.0 6.0 5.0 (1/4–3/16) | 7.0 (1/4) | 7.0 6.0 5.0 (1/4–3/16) | |
| | |  | 5.0 (3/16) | 2.5–5.0 (3/32–3/16) | 2.5 (3/32) | 1.0–4.0 (1/16–3/16) | Button sewing |  | 3.5 (1/8) | 2.5–4.5 (3/32–3/16) | – | – |
| | |  | 5.0 (3/16) | 0.0–7.0 (0.0–1/4) | 2.5 (3/32) | 0.5–3.0 (1/32–1/8) | Basting |  | 0.0 (0.0) | 0.0–7.0 (0–1/4) | 20 (13/16) | 5–30 (3/16–1/316) |
| | |  | 5.0 (3/16) | 3.5–5.0 (1/8–3/16) | 2.5 (3/32) | 1.0–4.0 (1/16–3/16) | Applique |  | 3.5 (1/8) | 2.5–5.0 (3/32–3/16) | 2.5 (3/32) | 1.6–2.5 (1/16–3/32) |
| | |  | 5.0 (3/16) | 0.0–7.0 (0.0–1/4) | 2.5 (3/32) | 0.5–3.0 (1/32–1/8) | |  | 1.5 (1/16) | 0.5–3.5 (1/32–1/8) | 1.4 (1/64) | 0.8–4.0 (1/16–3/16) |
| | |  | 4.0 (3/16) | 0.0–7.0 (0.0–1/4) | 4.0 (3/16) | 1.0–4.0 (1/16–3/16) | Scallop |  | 5.0 (3/16) | 2.5–7.0 (3/32–1/4) | 0.4 (1/64) | 0.1–1.0 (1/64–1/16) |
| | Blind hem stitch |  | 0.0 (0.0) | +3 – –3 | 2.0 (1/16) | 1.0–3.5 (1/16–1/8) | Smocking stitch |  | 5.0 (3/16) | 1.5–7.0 (1/16–1/4) | 1.6 (1/16) | 0.2–4.0 (1/64–1/16) |
| | |  | | | | Patchwork stitch |  | 5.0 (3/16) | 2.5–7.0 (3/32–1/4) | 2.5 (3/32) | 1.0–2.5 (1/16–3/32) | |
| Buttonhole |  | 5.0 (3/16) | 3.0–5.0 (1/8–3/16) | 0.4 (1/64) | 0.2–1.0 (1/64–1/16) | |  | 4.0 (1/16) | 0.0–7.0 (0.0–1/4) | 1.2 (1/16) | 0.2–4.0 (1/64–1/16) | |
| | |  | 5.0 (3/16) | 3.0–5.0 (1/8–3/16) | 0.4 (1/64) | 0.2–1.0 (1/64–1/16) |  | 5.0 (3/16) | 0.0–7.0 (0.0–1/4) | 1.2 (1/16) | 0.2–4.0 (1/64–1/16) | |
| | |  | 5.0 (3/16) | 3.0–5.0 (1/8–3/10) | 0.4 (1/64) | 0.2–1.0 (1/64–1/10) | Fagoting |  | 5.0 (3/16) | 0.0–7.0 (0.0–1/4) | 2.5 (3/32) | 2.5–3.0 (3/32–1/8) |
| | |  | 5.0 (3/16) | 3.0–5.0 (1/8–3/16) | 0.4 (1/64) | 0.2–1.0 (1/64–1/16) | |  | 5.0 (3/16) | 2.5–7.0 (3/32–1/4) | 2.5 (3/32) | 1.0–2.5 (1/16–3/32) |
| | |  | 6.0 (1/4) | 3.0–6.0 (1/8–1/4) | 1.0 (1/16) | 0.5–2.0 (1/32–1/16) | | | | | | |
| | |  | 6.0 (1/4) | 3.0–6.0 (1/8–1/4) | 1.5 (1/16) | 1.0–3.0 (1/16–1/8) | | | | | | |
| | |  | 5.0 (3/16) | 0.0–6.0 (0.0–1/4) | 2.0 (1/10) | 0.2–5.0 (1/64–3/16) | | | | | | |

| STITCH | | Stitch width [mm (inch.)] | | Stitch length [mm (inch.)] | |
|------------------------------|---|---------------------------|-----------------------|----------------------------|------------------------|
| | | Auto. | Manual | Auto. | Manual |
| Decorative stitch |  | 4.0 (3/16) | 0.0–7.0 (0.0–1/4) | 2.5 (3/32) | 1.0–4.0 (1/16–3/16) |
| |  | 4.0 (3/16) | 0.0–7.0 (0.0–1/4) | 3.0 (1/8) | 2.0–4.0 (1/16–3/16) |
| |  | 5.5 (3/16) | 0.0–7.0 (0.0–1/4) | 1.6 (1/16) | 1.0–4.0 (1/16–3/16) |
| |  | 3.5 (1/8) | 0.0–7.0 (0.0–1/4) | 1.6 (1/16) | 0.2–4.0 (1/64–1/16) |
| |  | 0.0 (0) | 0.0–7.0 (0.0–1/4) | 2.5 (3/32) | 1.0–4.0 (1/16–3/16) |
| |  | 5.0 (3/16) | 1.5–7.0 (1/16–1/4) | 1.0 (1/16) | 0.2–4.0 (1/64–3/16) |
| Lateral sewing (Straight) |  | - | - | - | - |
| |  | - | - | - | - |
| |  | - | - | - | - |
| |  | - | - | - | - |
| |  | - | - | - | - |
| |  | - | - | - | - |
| |  | - | - | - | - |
| |  | - | - | - | - |
| Lateral sewing (Zigzag) |  | - | - | - | - |
| |  | - | - | - | - |
| Heirloom |  | 6.0 (1/4) | 1.5–7.0 (1/16–1/4) | 2.5 (3/32) | 1.5–4.0 (1/16–3/16) |
| |  | 5.0 (3/16) | 2.0–7.0 (1/16–1/4) | 1.6 (1/16) | 1.0–4.0 (1/16–3/16) |
| |  | 5.0 (3/16) | 1.5–7.0 (1/16–1/4) | 4.0 (3/16) | 1.5–4.0 (1/16–3/16) |
| |  | 3.5 (1/8) | 1.5–7.0 (1/16–1/4) | 3.0 (1/8) | 1.6–4.0 (1/16–3/16) |
| |  | 5.0 (3/16) | 3.0–7.0 (1/8–1/4) | 3.5 (1/8) | 2.0–4.0 (1/16–3/16) |

*-: Non-adjustable



THREAD TENSION

Correct tension

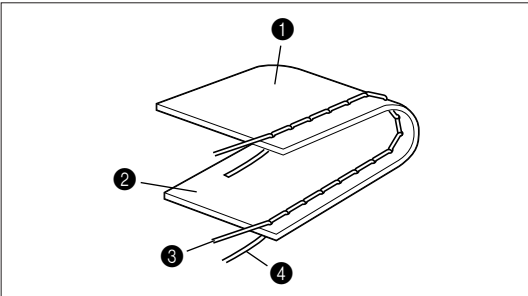

- ① Reverse side
- ② Surface
- ③ Upper thread
- ④ Bobbin thread

* Thread tension is automatically set to the most appropriate point irrespective of the chosen fabric and thread.
* Correct tension is important because too much or too little tension will weaken your seams or cause your fabric to pucker.

Loosen tension by touching “◀” (Weak).

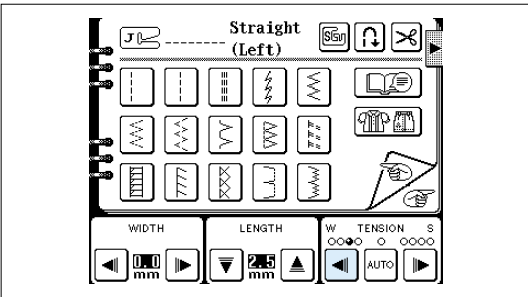

Touch the “◀” thread tension setting key. The thread tension value will decrease (become weaker).

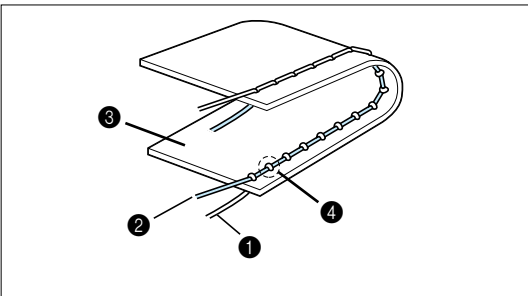

- ① Bobbin thread
- ② Upper thread
- ③ Surface
- ④ Locks appear on surface of fabric.

Tighten tension by touching “▶” (Strong).

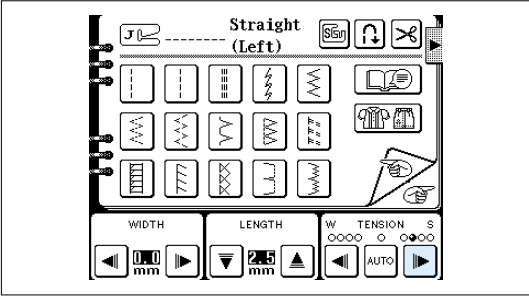

Touch the “▶” thread tension setting key. The thread tension value will increase (become stronger).

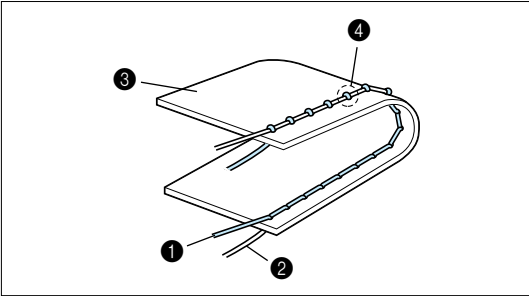

- ❶ Upper thread
- ❷ Bobbin thread
- ❸ Reverse side
- ❹ Locks appears on reverse side of fabric.

Except “UTILITY STITCH”

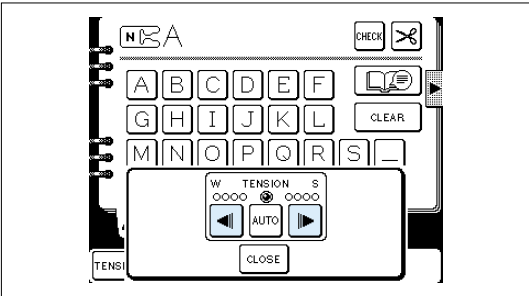

1. Touch the “TENSION” key.
 2. Change the upper thread tension.
- * If you touch the “CLOSE” key, the display will return to the previous screen.

CHANGING THE PRESSER FOOT

Change the presser foot according to the LCD message

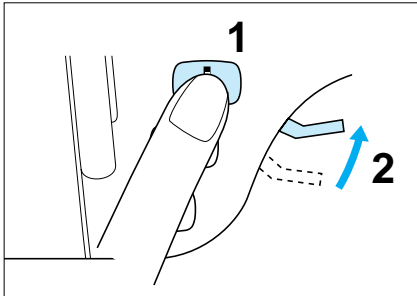

1. Push the “NEEDLE POSITION” button to raise the needle, and then turn off the power.
2. Raise the presser foot lever.

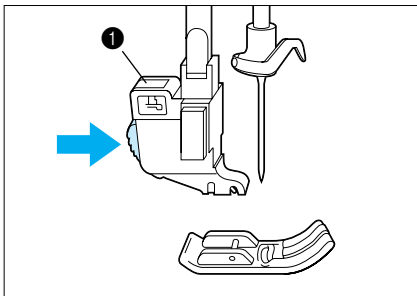

3. Press the black button located at the back of the presser foot holder to release the foot.

① Presser foot holder

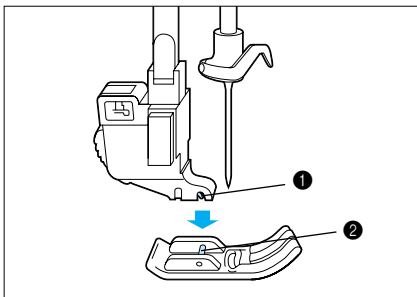

4. Place the presser foot pin directly below the holder-end and lower the presser foot lever.

① Holder-end

② Foot pin

Installing embroidery foot “Q”

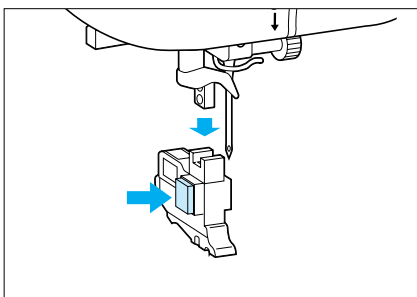

1. Push the “NEEDLE POSITION” button to raise the needle, and then turn off the power.
2. Raise the presser foot lever.
3. While pressing the black button to the left of the presser foot holder, pull the presser foot holder downward to remove it.

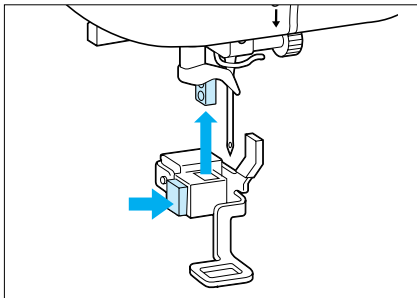

4. Raise the presser foot lever to the highest position. While pressing the black button to the left of the embroidery foot “Q”, push embroidery foot “Q” upward with both hands as far as it will go to install it.

CAUTION
 Be careful not to touch the needle during this time, otherwise injury may result.

Optional

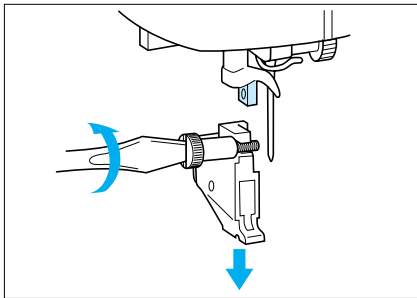

1. Press the “NEEDLE POSITION” button to raise the needle, and then turn off the power.
2. Raise the presser foot lever.
3. Loosen the screw to remove the presser foot holder.

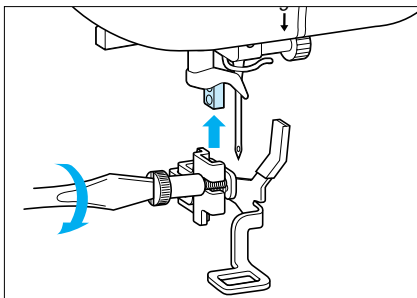

4. Attach the embroidery foot “Q”.
5. Set arm of embroidery foot “Q” on needle bar, use the metal disk provided with your machine (accessory #14 on page 7) or a screwdriver to tighten the screw firmly.

CAUTION
 Be careful not to touch the needle during this time, otherwise injury may result.

- NOTE**
- Make sure that there is no gap between the needle bar and embroidery foot “Q”.
 - It is recommended that a 90/14 needle should be used when embroidering on thicker fabrics or stabilizing products. (for example denim, puffy foam . . .) A 75/11 needle might be bent or broken, which could result in injury.

Changing the embroidery foot

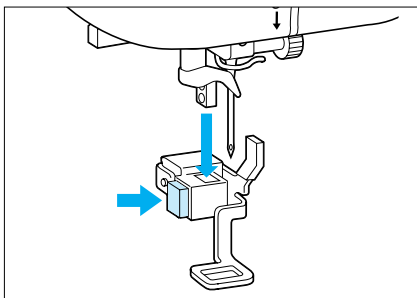

1. Raise the presser foot lever to the highest position. While pressing the black button to the left of embroidery foot “Q”, pull embroidery foot “Q” downward to remove it.

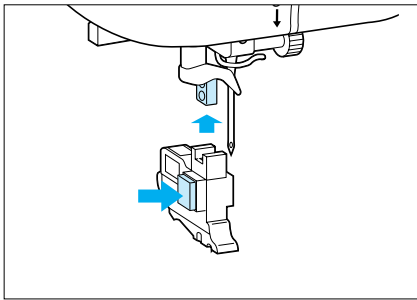

2. While pressing the black button to the left of the presser foot holder, push the presser foot holder upward with both hands as far as it will go to install it.

CAUTION
 Be careful not to touch the needle during this time, otherwise injury may result.

Optional

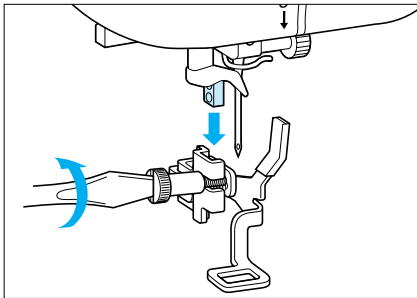

1. Press the "NEEDLE POSITION" button to raise the needle, and then turn off the power.
2. Raise the presser foot lever.
3. Loosen the screw to remove the embroidery foot "Q".

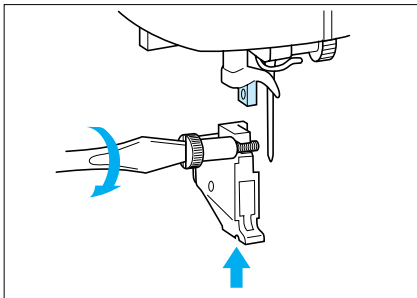

4. With the presser foot lever raised, tighten the screw lightly to attach the presser foot holder.
5. Lower the presser foot lever and use the metal disk provided with your machine (accessory #14 on page 7) or a screwdriver to tighten the screw firmly.

CAUTION
 Be careful not to touch the needle during this time, otherwise injury may result.

NOTE
 – If the presser foot is not installed correctly, the thread tension may loosen due to improper presser foot height.

Feed dog adjustment

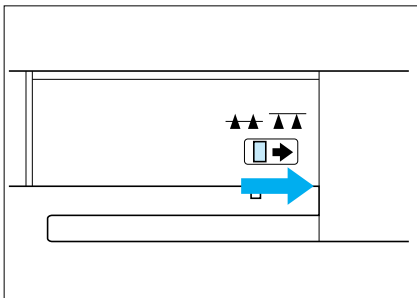

With the accessory compartment off the machine, the feed dog adjustment lever can be seen on the base of the machine. Sliding the lever to the right will lower the feed dogs. Feed dogs are lowered during button sewing as well. If you are continuing to sew, slide the lever to the left and the feed dogs will raise.

* When the embroidery unit is on to the machine, the feed dogs drop automatically.

CHANGING THE NEEDLE

Setting the needle securely

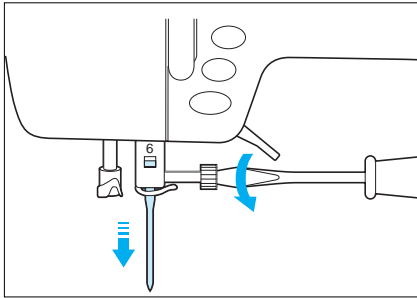

1. Press the “NEEDLE POSITION” button to raise the needle.
2. Turn off the power and lower the presser foot.
3. Loosen the needle clamp screw with a screwdriver.
4. Pull out the needle.

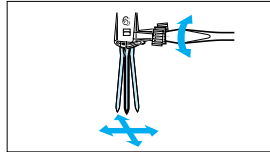

CAUTION
Do not loosen or tighten the needle clamp screw with a strong force, otherwise it may be damaged

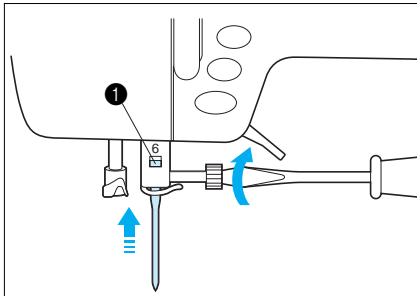

5. With the flat side of the needle facing the back, insert the needle as far as it will go up against the needle stopper. Fasten the screw securely with a screwdriver.

- ① Needle stopper
6. Turn the power on.

Checking needle

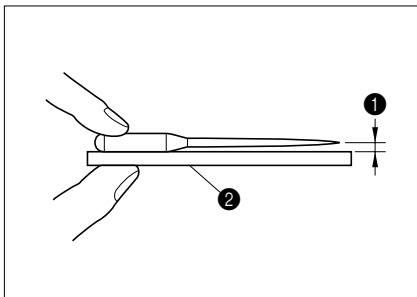

Place the needle on a flat surface and check whether the space between the needle and the flat surface is parallel or not.

If the space is not parallel then the needle is bent and should be thrown away to prevent damage to your project or to the machine.

- ① Space between the needle and the flat surface
- ② Flat surface (needle plate, glass, ruler, etc.)

MACHINE OPERATION KEYS

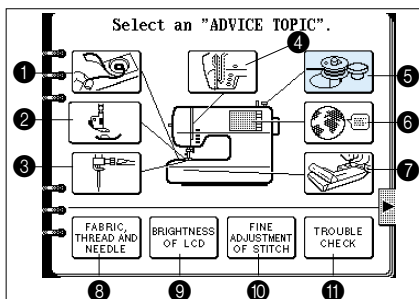



This machine contains built-in instructions on how to use the machine which are based on this operation manual. If you touch the “OPERATION GUIDE” key, details of basic operations such as bobbin winding and upper threading will appear on the LCD, so that you can refer to these instructions while using the machine.

Example: If you would like to know how to wind the bobbin thread

1. Touch the “OPERATION GUIDE” key. A screen such as left will be displayed.

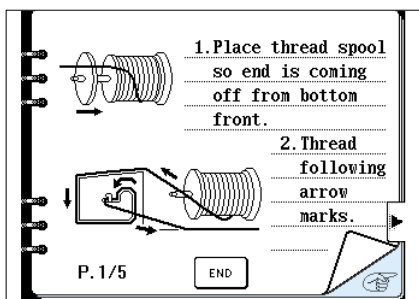
- ❶ Touch this key to find out how to set the bobbin thread.
- ❷ Touch this key to find out how to replace the presser foot.
- ❸ Touch this key to find out how to replace the needle.
- ❹ Touch this key to find out how to thread the upper thread.
- ❺ Touch this key to find out how to wind the bobbin thread.
- ❻ Touch this key to find out how to select the language.
- ❼ Touch this key to find out how to embroider.
- ❽ Touch this key to find out which thread and needle to use for different fabrics.
- ❾ Touch this key if the screen is difficult to read.
- ❿ Touch this key if the pattern is distorted.
- ⓫ Touch this key if a problem occurs while sewing.



2. Touch the “” key.

The procedure for winding the bobbin thread onto the bobbin will be displayed.

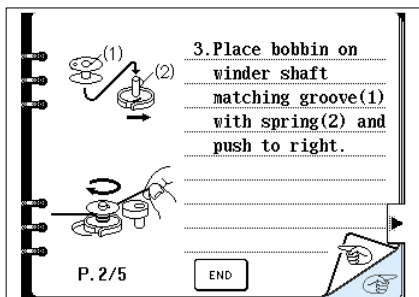

3. Touch the “” key to display the next part of the procedure. Follow the procedure to wind the bobbin thread onto the bobbin.

* Touch the “END” key to return to the original screen.

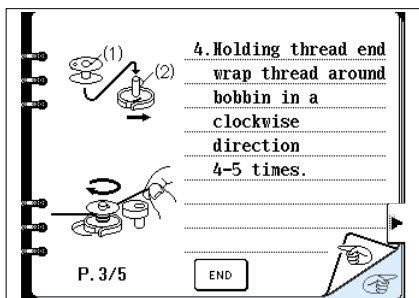

TRIAL SEWING

Sewing by using “UTILITY STITCH”

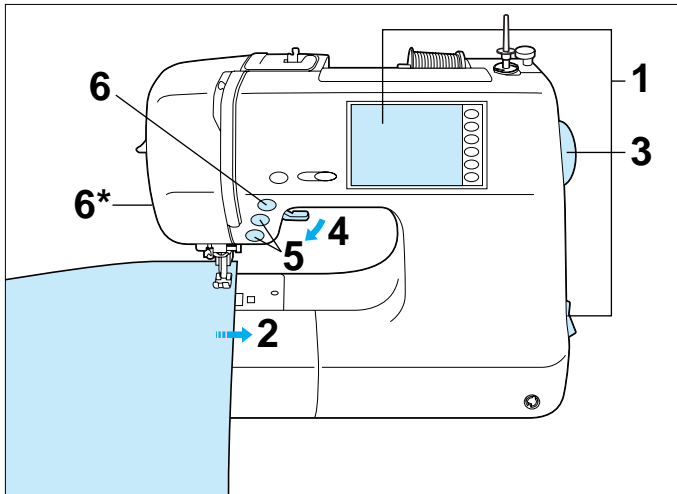

CAUTION

- Be aware of the needle at all times while sewing, and keep your hands away from all moving parts such as the needle, balance wheel and thread take-up lever, otherwise injury may result.
- Do not pull or push the fabric too hard while sewing, otherwise injury may result.
- Never use bent needles. Such needles can easily break, which could result in injury.

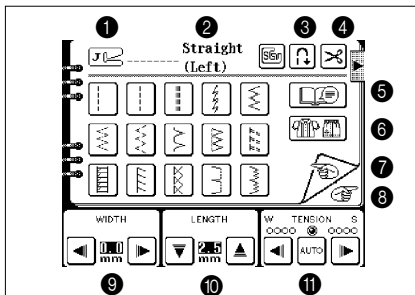

A 75/11 needle is inserted into the machine at the factory.

1. When the machine is turned on, the straight stitch (left) is always selected.

- ① Replace with the presser foot with the letter indicated.
- ② This indicates the pattern being selected.
- ③ If you touch this key before sewing, reverse stitches (reinforcement stitches) will be sewn automatically. (Refer to page 38.)
- ④ If you touch this key before sewing, the thread will be automatically cut at the finish of sewing. (Refer to page 39.)
- ⑤ An advice screen will appear if you touch this key while sewing. (Refer to page 42.)
- ⑥ This selects the appropriate pattern for the sewing application and also displays the operation steps. (Refer to page 40.)
- ⑦ Touch this key to return to the previous page.
- ⑧ Touch this key to move to the next page.
- ⑨ Touch these keys to adjust the stitch width setting.
- ⑩ Touch these keys to adjust the stitch length setting.
- ⑪ Touch these keys to change the thread tension.

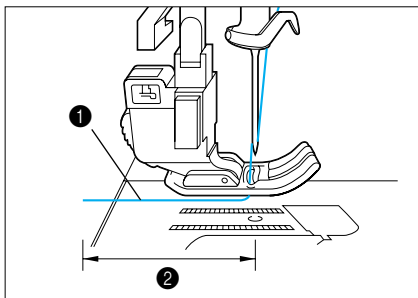

2. Pass the thread underneath the presser foot and pull it out from the rear of the machine by about 5 cm.

- ① Upper thread
- ② 5 cm (1-15/16")

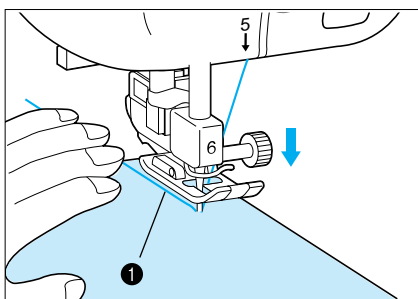

3. While holding on the thread tails and the fabric with your left hand, turn the balance wheel with your right hand to move the needle to the sewing start position.

- ① Thread

* Sewing can begin without pulling out the bobbin thread.

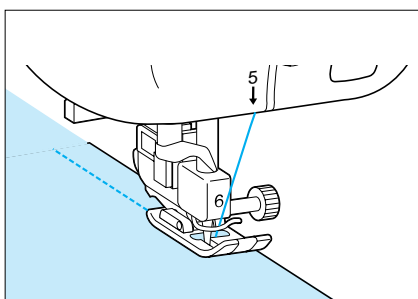

4. Lower the presser foot. Press the "REVERSE STITCH" button to sew a reverse stitch, and then press the "START/STOP" button. The machine will start to run at slow speed.

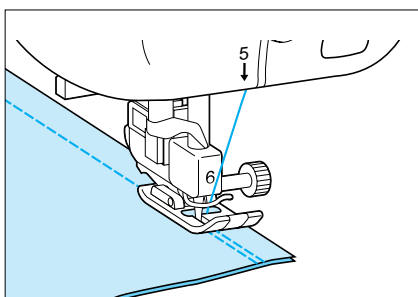

5. When sewing is completed, press the "REVERSE STITCH" button to sew a reverse stitch.

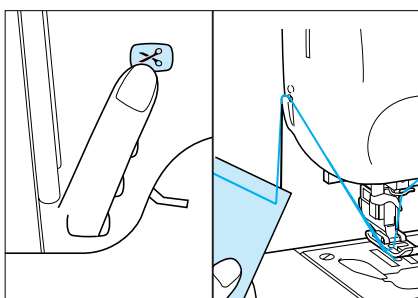

6. Press the "THREAD CUTTER" button to cut the threads .

*6. Cut thick thread (thicker than # 30) with the cutter on the side of the machine as illustrated.

* BOBBIN THREAD SENSOR

If a warning message appears on the message screen, the bobbin thread is running out. Replace the bobbin thread at this time.

- Setting Up
- Sewing
- Utility Stitches
- Characters and Decorative Stitches
- Embroidering
- Editing Embroidery Patterns
- Retrieving
- My Custom Stitch™
- Maintenance
- Error Messages
- Trouble shooting
- Sewing Chart
- Patterns (Programmed in Machine)
- Patterns (Memory Card)

AUTOMATIC REINFORCEMENT STITCHING

This stitch automatically prevents fraying.

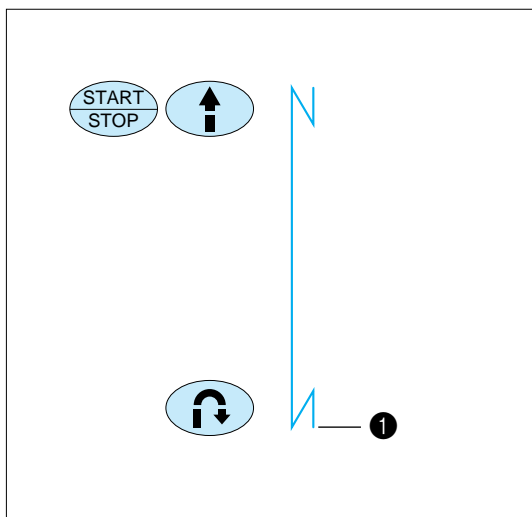
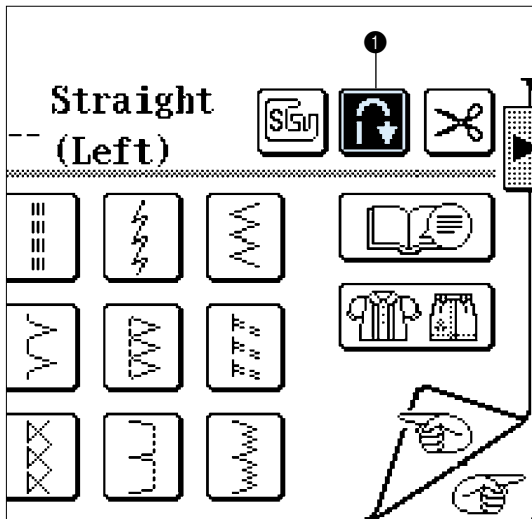

1. Select the stitch pattern.
2. Touch the automatic reinforcement stitch key.

① Automatic reinforcement stitch key

3. Press the “START/STOP” button.
A reinforcement stitch will be sewn before sewing starts. A reinforcement stitch will not be done if there is a pause in sewing. Press the “START/STOP” button to pause sewing. An ending reinforcement stitch will not be sewn. (The fabric may be turned or adjusted as required.) Press the “START/STOP” button again to restart sewing.
4. When sewing is completed, press the “REVERSE STITCH” button to sew a reinforcement stitch and stop.

① Automatically stops.

* Fabric should be placed 3 to 4 stitch lengths behind the presser foot before sewing the reinforcement stitch.

Cancelling automatic reinforcement stitching

Touching the automatic reinforcement stitch key once again, turns off the automatic reinforcement stitch operation.

AUTOMATIC THREAD CUTTING

The thread can be cut automatically.

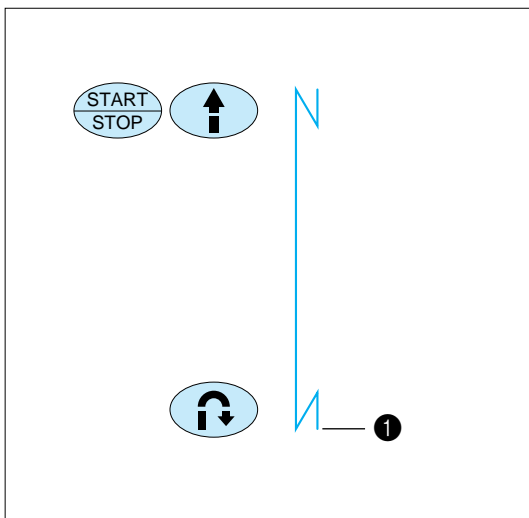
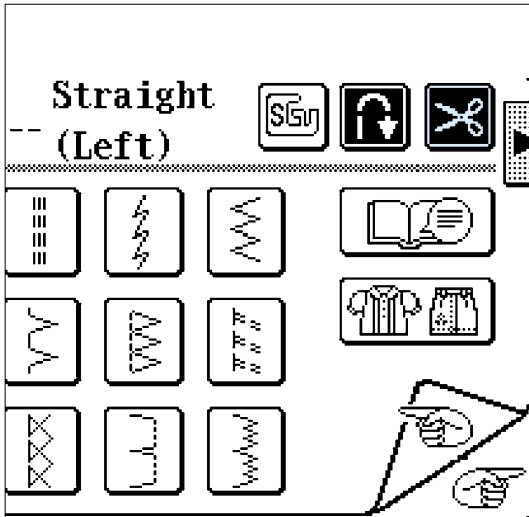

Cancelling programmed automatic thread cutting

If you set programmed automatic thread cutting prior to sewing, the machine will automatically trim the thread when the pattern has been completed. (Reinforcement stitches are used at the start and finish of the pattern.)

1. Select the stitch pattern.
2. Touch the automatic thread cutting key.
 - * Automatic thread cutting and the automatic reinforcement stitch must be used together.
 - * Automatic thread cutting is convenient for use on buttonholes, bar tacking and other areas.
3. Press the "START/STOP" button. A reinforcement stitch will be sewn before sewing starts.
4. When sewing is completed, press the "REVERSE STITCH" button to sew a reinforcement stitch and trim the thread.
 - ① Automatically trims the thread and stops.
 - * Fabric should be placed 3 to 4 stitch lengths behind the presser foot before sewing the reinforcement stitch.

Touching the automatic thread cutting key again turns off the automatic thread cutting function.

UTILITY STITCH SELECTION

(Example) Buttonholes

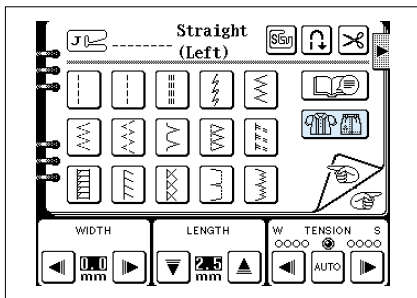

1. Touch the "UTILITY STITCH" key.
2. Touch the " " key.

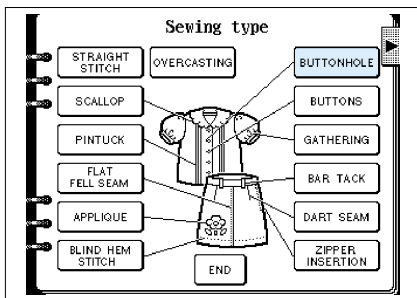

3. Touch the "BUTTONHOLE" key.

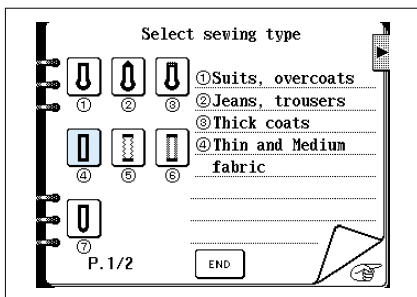

4. Select the desired application.
The stitches available and sewing procedure appear on the screen step by step.

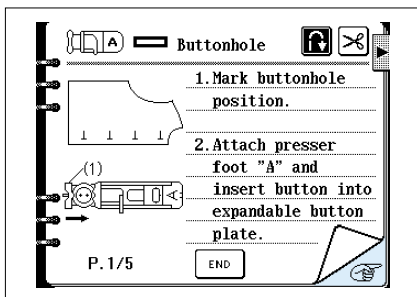

5. Touch the " " key to display the next part of the procedure.
Follow the procedure to sew the buttonhole stitches.

* Touch the "END" key to return to the original screen.

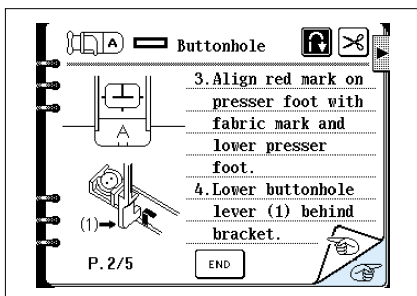

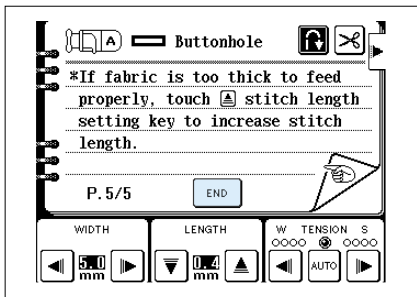
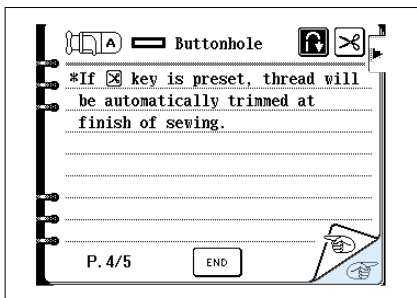
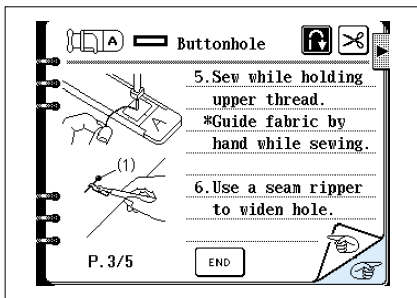



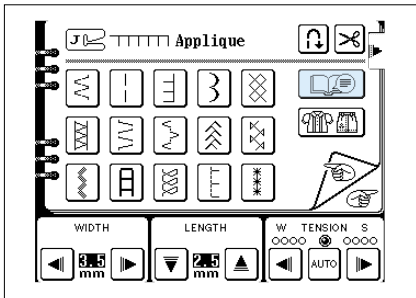

USEFUL SKILLS

The “” key

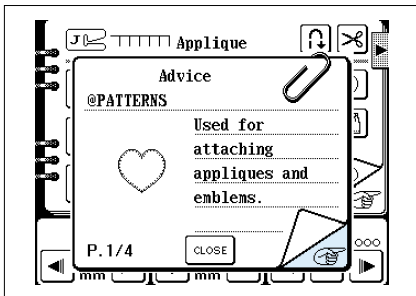

1. Touch the “” key. If the “” key is touched while the “” stitch is selected, the following screen will be displayed.



2. Touch the “” key to display the next part of the procedure.

* Touch the “CLOSE” key to return to the original screen.

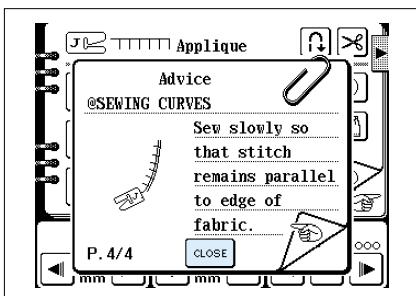
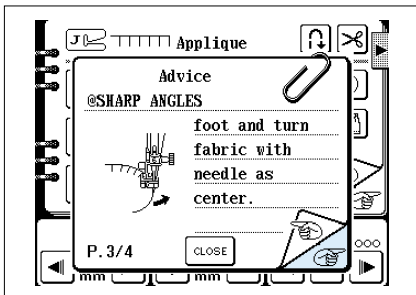
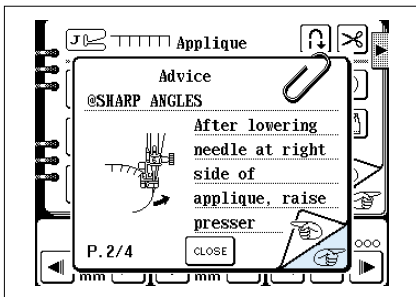

Sewing corners

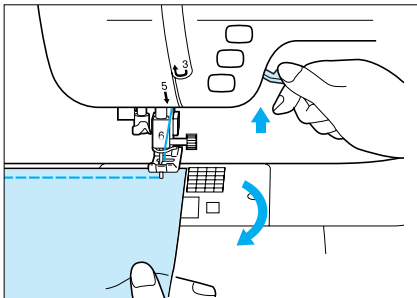

Keep the needle at the corner of the fabric, then raise the presser foot and turn the fabric.

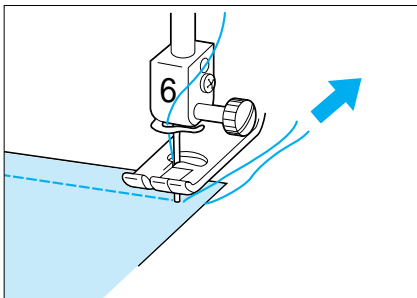

For short stitches which are less than 0.5 cm (3/16")

Before you begin to sew, set a basting thread at the corner point. When you change direction at the corner, start sewing as you pull the basting thread backward.

Sewing thick seams

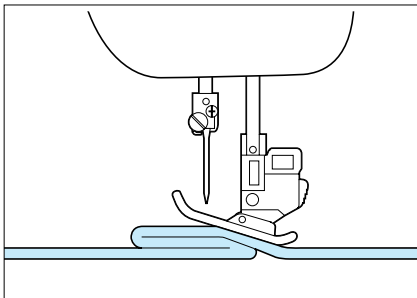

When the foot angles up at the approach of a thick seam, lower the needle and raise the presser foot. Level the presser foot by placing a "shim" (folded fabric or cardboard) under the back of the presser foot. Lower presser foot and continue stitching.

Sewing curves

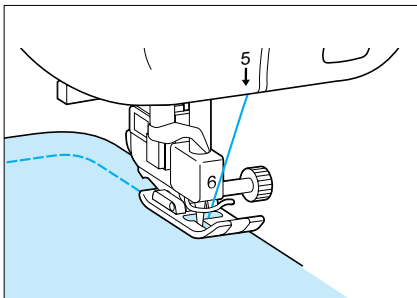

Sewing a curve with a straight stitch

Sew slowly, while keeping the seams parallel with the fabric edge as you guide the fabric around the curve.

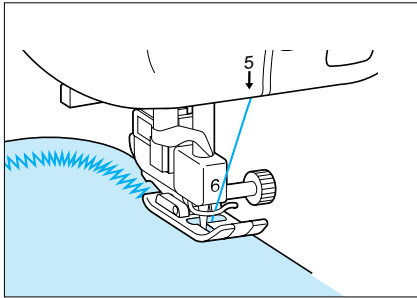

Sewing a curve with a zigzag stitch

Set the stitch length short in order to obtain a fine stitch. Sew slowly while keeping the seams parallel with the fabric edge as you guide the fabric around the curve.

- * For sharp corners, temporarily stop sewing while keeping the needle in the material, then raise the presser foot and carefully turn the fabric while keeping it level with the presser foot. Lower the presser foot and continue sewing.

Sewing thick fabric

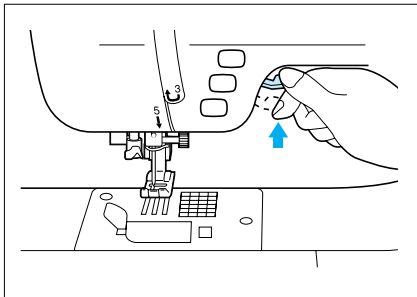

1. When you raise the presser foot lever further, the presser foot is raised to a higher position to handle thicker fabrics. With the presser foot in the up position, raise the presser foot lever higher to make room for thicker fabrics.

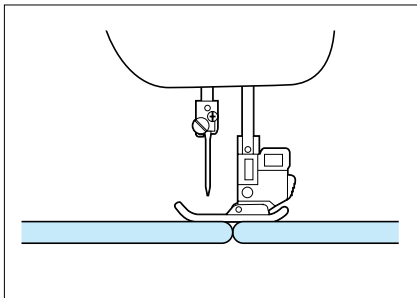

2. If the fabric will not feed at the beginning of sewing, place another piece of fabric with the same thickness at the back of the material.

- * Using a straight stitch foot (optional accessory item SA108 or X80823001) will stop the fabric lifting up and down as the needle pierces very thick fabrics. Remember that this foot is only to be used with the straight stitch in the center needle position.

Sewing thin fabric

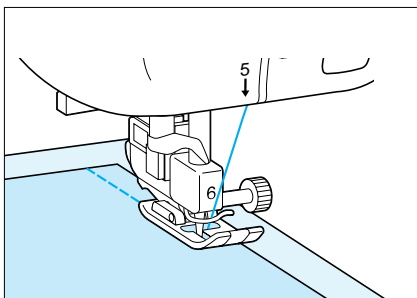

Place thin paper or stabilizer material under the fabric, and then start sewing.

- * Use a straight stitch foot (optional accessory item SA108 or X80823001) to eliminate any puckering. Remember to select the center needle position. Additional adjustment of stitch length and tension may be necessary.

2. UTILITY STITCHES

STRAIGHT STITCHES

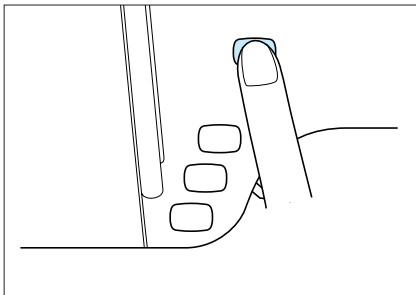
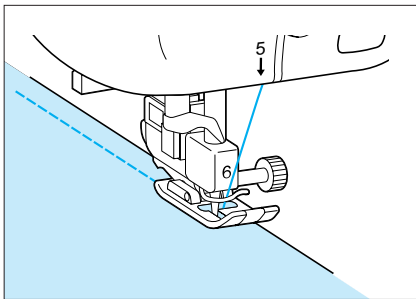
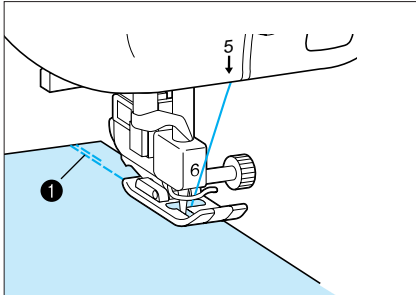
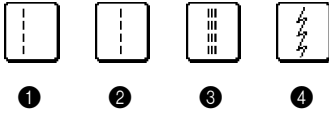

- ① Normal sewing
- ② Normal sewing
- ③ Reinforced sewing
- ④ Stretch fabric sewing

1. Baste the fabric or set a pin, sew a reverse stitch at the start, then start sewing.

- ① Reverse stitch at start

* Place the fabric under presser foot while keeping space from the top edge of the fabric for reverse sewing.

2. Sew at slow speed near the end and then press the “REVERSE STITCH” button to sew a reinforcement stitch and stop.

3. Cut the thread by pressing the “THREAD CUTTER” button.

* When the automatic thread cutting and automatic reinforcement stitch are preset, reinforcement stitches will be sewn automatically at the start of sewing. Press the “REVERSE STITCH” button to sew a reinforcement stitch and trim the thread automatically at the finish of sewing.

For reinforcement stitching on stretch fabric

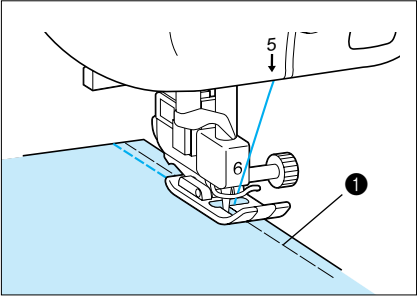

Baste the fabric beforehand and sew along to the basting using a stretch stitch.

* Do not pull the fabric during sewing.

- ① Basting

Changing the stitch length

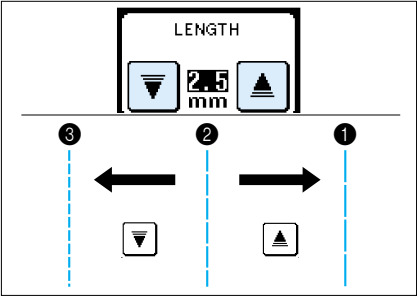

Touch the “▲” and “▼” stitch length setting keys to adjust the stitch length.

- ① Longer
- ② Original length: 2.5 mm (1")
- ③ Shorter

* For thin material which is less than 1 mm (1/16"), the stitch length will be set to 4.0 mm (3/16") automatically during sewing even if you set the length to 5.0 mm (3/16").

Changing the needle position

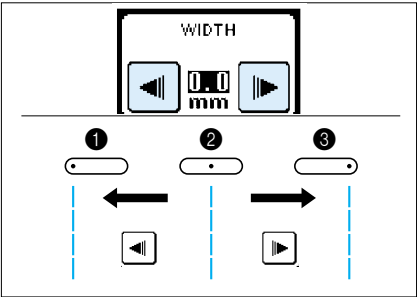

Touch the “◀” and “▶” stitch width setting keys to adjust the needle position.

- ① Left needle position: 0 mm (0")
- ② Center needle position: 3.5 mm (1/8")
- ③ Right needle position: 7.0 mm (1/4")

* The needle position cannot be changed for the straight stitch/center position selection “□”.

ADAPTER FOR LOW SHANK ATTACHMENTS

This adapter is used for attaching screw-on presser feet to this machine. Following is explanation about installation of walking foot.

Included accessories

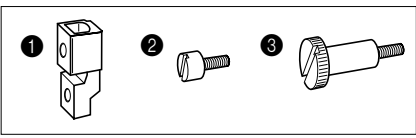

- ❶ Adapter
- ❷ Screw (small) *
- ❸ Screw (large) **

Installation of walking foot

This foot is very useful for sewing materials such as vinyl cloth, synthetic leather, thin leather, etc. These materials are difficult to be fed when sewing but this foot can prevent such materials from crumpling, slipping or sticking between presser foot and materials thanks to even feeding upper and lower materials.

You can use walking foot only for sewing STRAIGHT STITCH () and ZIGZAG STITCH ().

You can not use this foot for sewing other patterns including horizontal feed (STRAIGHT & ZIGZAG STITCH).

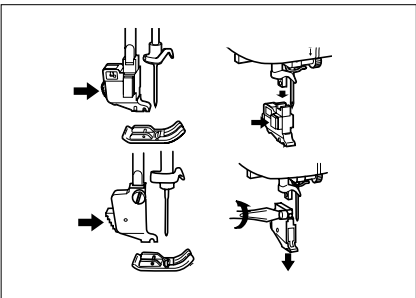

1. Remove the presser foot and the presser foot holder.

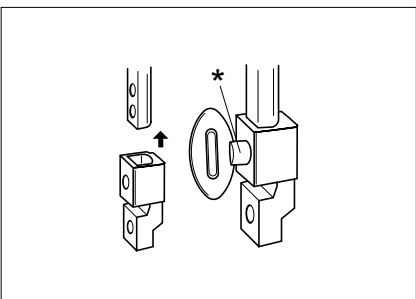

2. Attach the adapter for low shank attachments.
 - * Push the adapter up onto the end of the presser bar as far as possible.
 - * Use the metal disk provided with your machine (accessory #14 on page 7) or screw driver to tighten the screw (small) firmly.
 - * When attaching the adapter, be sure to use the metal disk or screw driver to tighten the screw firmly. If the screw is not completely tightened, injuries may occur.

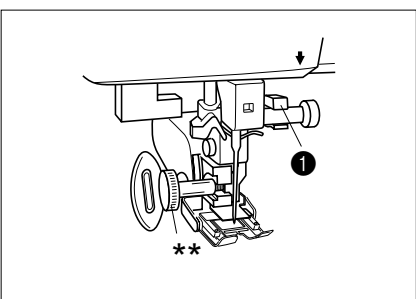

3. Fix the connecting lever of Walking foot to the needle fixing screw and install Walking foot onto the presser bar. Lower the presser foot and tighten the presser foot holder screw (large).
 - ** Before sewing, be sure to turn the balance wheel toward you slowly to check that the needle does not touch the presser foot, otherwise injuries may occur. Please sew with slow to medium speed.

- ❶ Connection lever

ZIGZAG STITCHES



Setting Up

Sewing

Utility Stitches

Characters and Decorative Stitches

Embroidering

Editing Embroidery Patterns

Retrieving

My Custom Stitches™

Maintenance

Error Messages

Trouble shooting

Sewing Chart

Patterns (Programmed in Machine)

Patterns (Memory Card)

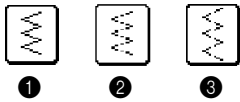

- 1 Zigzag stitch
- 2 Elastic zigzag stitch
- 3 Elastic zigzag stitch

Overcasting (using a zigzag stitch)

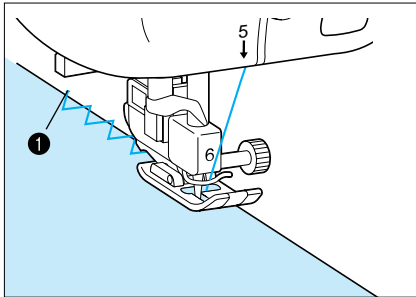

Sew the overcasting along the edge of the fabric so that the right hand side needle drop point is over the edge of the fabric.

- 1 Needle drop point

Applique (using a zigzag stitch)

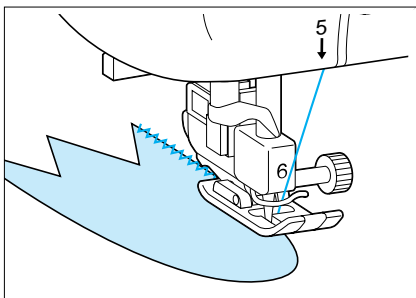

Attach the applique using adhesive or basting, then sew it.

- * Sew a zigzag stitch, while positioning the right hand needle drop point just outside the edge of the fabric.

Patchwork (for crazy quilt)

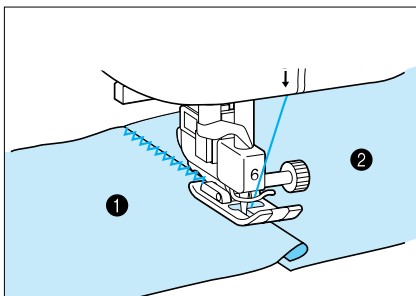

Turn back the desired width of fabric and position it over the lower fabric, then sew so that the stitch bridges both pieces of fabric.

- 1 Upper fabric
- 2 Lower fabric

OVERCASTING



Setting Up

Sewing

Utility Stitches

Characters and Decorative Stitches

Embroidering

Editing Patterns

Retrieving

My Custom Stitch™

Maintenance

Error Messages

Trouble shooting

Sewing Chart

Patterns (Programmed in Machine)

Patterns (Memory Card)

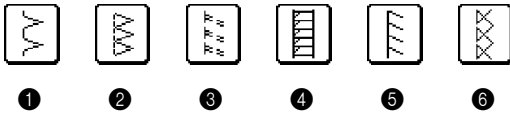

- ① Thin and medium fabrics
- ② Thick fabric
- ③ Thick and medium stretch fabric
- ④ Medium stretch fabric
- ⑤ Stretch fabric
- ⑥ Stretch fabric

When using , or stitches

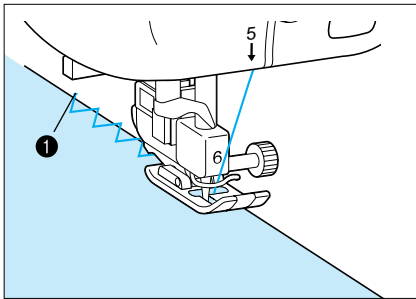

Sew the fabric while placing fabric edge against the guide of presser foot “G”.

- ① Guide

* When the automatic thread cutting and automatic reinforcement stitch are preset, a reinforcement stitch will be sewn automatically at the start of sewing. Press the “REVERSE STITCH” button to sew a reinforcement stitch and trim the thread automatically at the finish of sewing.

CAUTION

After the stitch width has been adjusted, turn the balance wheel by hand and check that the needle does not touch the presser foot.

If it does touch, the needle may break and injury could result.

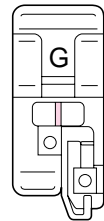

When using , or stitches

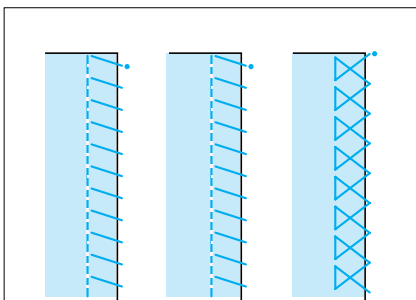

Attach presser foot “J” and let the needle drop slightly past the edge of the fabric before starting to sew.

* When the automatic thread cutting and automatic reinforcement stitch are preset, a reinforcement stitch will be sewn automatically at the start of sewing. Press the “REVERSE STITCH” button to sew a reinforcement stitch and trim the thread automatically at the finish of sewing.

OVERCASTING (When using the side cutter)

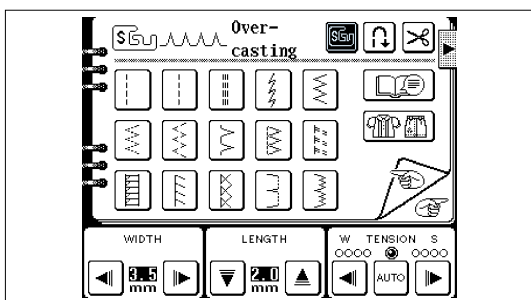
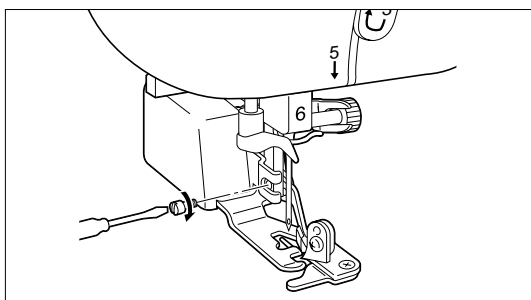
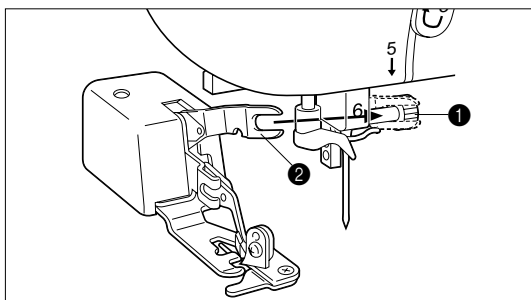
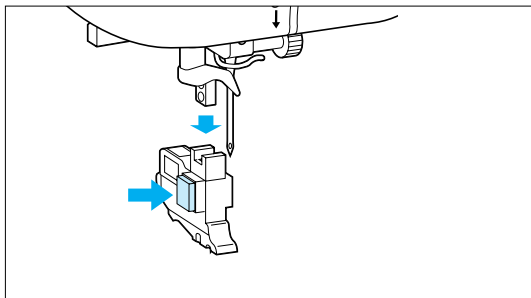

- ① Thin and medium fabrics
- ② Thick fabric
- ③ Thick and medium stretch fabric
- ④ Normal sewing
- ⑤ Zigzag stitch

By using the side cutter, you can do overcasting while cutting the fabric.

If using the side cutter, select the pattern and then touch the “” key.

1. Push the “NEEDLE POSITION” button to raise the needle, and then turn off the power.
2. Raise the presser foot lever.
3. While pressing the black button to the left of the presser foot holder, pull the presser foot holder downward to remove it.
4. Set the screw of the needle bar into the fork of the operating lever.

- ① Screw of the needle bar
- ② Operating lever

* Make sure that the screw is held firmly by the fork.

5. With the presser foot raised, align the presser foot holder screw hole directly with the notch in the side cutter, then insert the screw provided in your accessory bag (accessory #3 on page 7) and lightly tighten it. Lower the presser foot lever and firmly tighten the screw.

6. Select the pattern and then touch the “” key. The necessary adjustment for the side cutter will be carried out automatically.

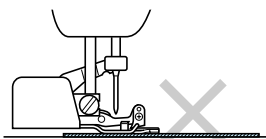
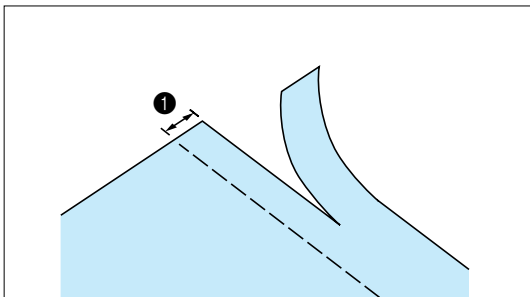
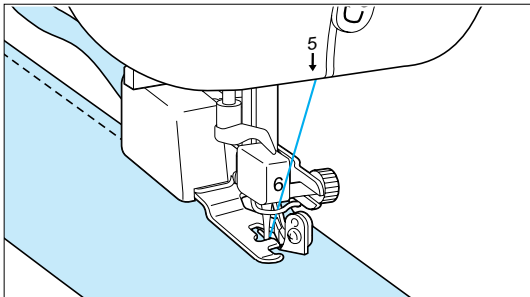
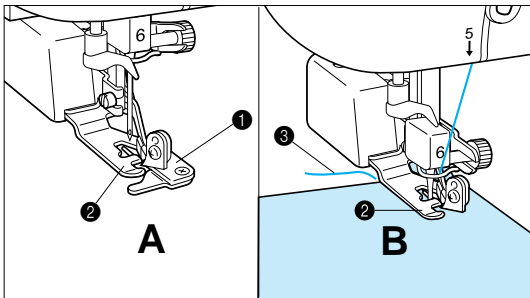
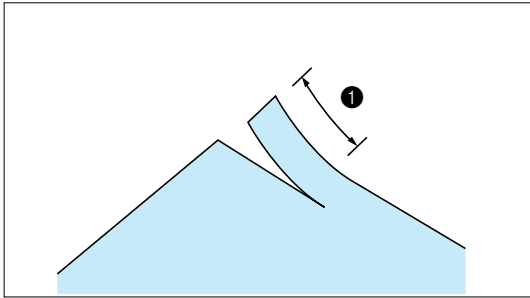

7. Make a cut of about 2 cm in the fabric.

① 2 cm

8. Place the fabric as shown left figure B.
 –Right side of cut: on top of the guide plate
 –Left side of cut: underneath the presser foot

① Guide plate (lower knife)
 ② Presser foot

9. Thread the needle, and then pull out a long section of the upper thread, pass it below the presser foot and pull it out in the fabric feed direction. (See left figure B)

② Presser foot
 ③ Upper thread

10. Lower the presser foot lever.

CAUTION

If the width has been adjusted, turn the balance wheel by hand to check that the needle does not touch the side cutter. If the needle touches the side cutter, it may cause the needle to break.

When sewing straight stitches only

The seam margin should be about 0.5 cm.

① Seam margin

- * Make sure that you touch the “” key when using the side cutter.
- * Clean the side cutter after use, otherwise dust and scraps of thread will build up on it.
- * Add a small amount of oil as required to the cutting edge of the cutter.

Note

- The fabric will not be cut if the whole fabric is simply spread out underneath the presser foot guide plate. Set the fabric as explained in step 8. above, and the start sewing.
- Check that the needle is raised when the presser foot lever is raised.
- One layer of 13-oz denim can be cut.

BLIND HEM STITCHES



- Setting Up
- Sewing
- Utility Stitches
- Characters and Decorative Stitches
- Embroidering
- Editing Embroidery Patterns
- Retrieving
- My Custom Stitch™
- Maintenance
- Error Messages
- Trouble shooting
- Sewing Chart
- Patterns (Programmed in Machine)
- Patterns (Memory Card)

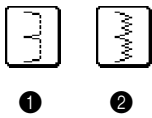

- ① Other fabric
- ② Stretch fabric

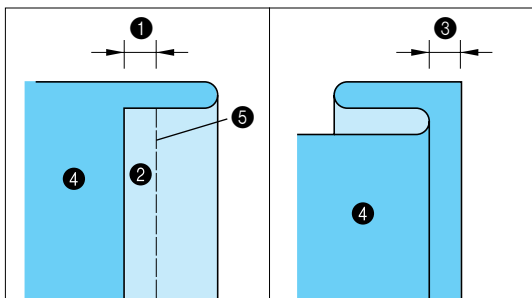

1. Fold the fabric and baste it as illustrated.

- ① 0.5 cm (3/16")
- ② Surface
- ③ 0.5 cm (3/16")
- ④ Reverse side
- ⑤ Basting stitch

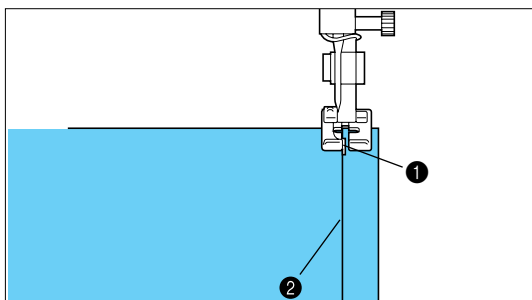

2. Attach presser foot "R". Lower the presser foot so that its guide meets the edge of the folded hem.

- ① Guide
- ② Folded hem

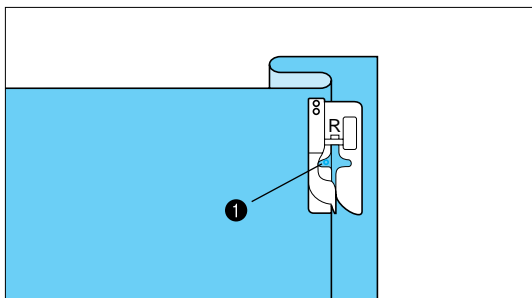

3. Adjust the needle position using the stitch width setting keys so that needle slightly catches the fold of the hem, and then sew the fabric.

- ① Needle drop position

* When the automatic thread cutting and automatic reinforcement stitch are preset, a reinforcement stitch will be sewn automatically at the start of sewing. Press the "REVERSE STITCH" button to sew a reinforcement stitch and trim the thread automatically at the finish of sewing.

4. Turn over the fabric and remove the basting stitch.

- ① Reverse side
- ② Surface

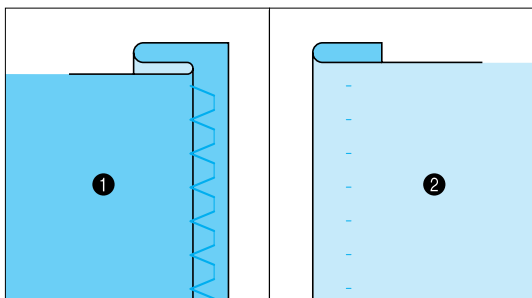

Adjusting the needle drop position

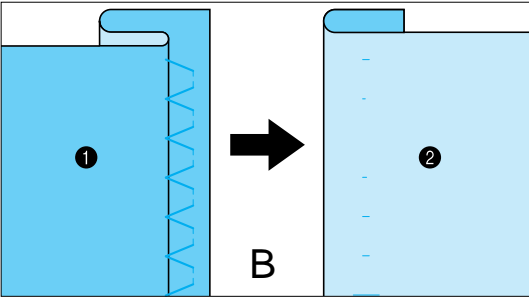
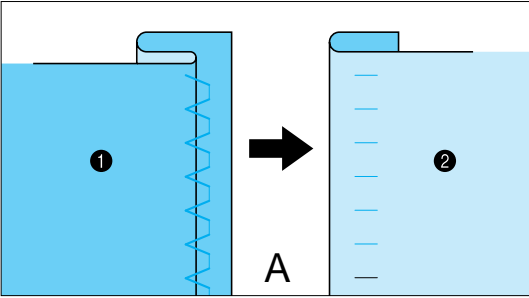
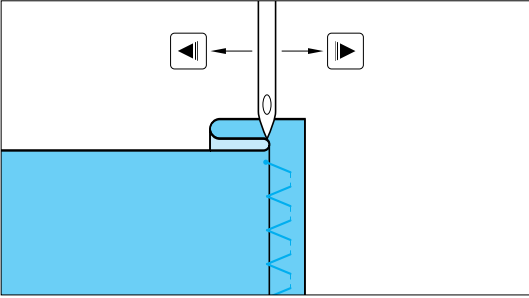

Touch the “◀” and “▶” stitch width setting keys to adjust the needle drop position so that the needle slightly catches the fold of the hem.

- A- If the needle catches the fold of hem too much.
 - Touch the “▶” stitch width setting key. This moves the needle away from the fold.
- B- If the needle does not catch the fold of hem enough.
 - Touch the “◀” stitch width setting key. This moves the needle closer to the fold.

- ① Reverse side
- ② Surface

BUTTONHOLE STITCHES



Setting Up

Sewing

Utility Stitches

Characters and Decorative Stitches

Embroidering

Editing Embroidery Patterns

Retrieving

My Custom Stitch™

Maintenance

Error Messages

Trouble shooting

Sewing Chart

Patterns (Programmed in Machine)

Patterns (Memory Card)

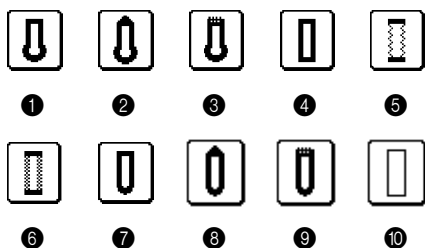

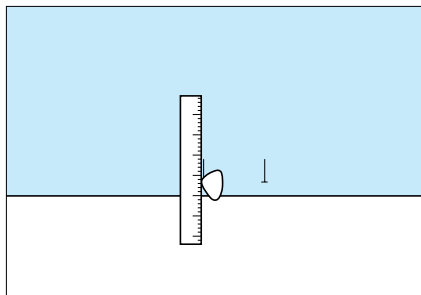

- ① Suits, overcoat
- ② Jeans, trousers
- ③ Thick coats
- ④ Thin or medium fabric
- ⑤ Stretch fabric with coarse weaves
- ⑥ Stretch fabric
- ⑦ Thin and medium fabric (for horizontal holes)
- ⑧ Jeans, trousers
- ⑨ Thick coats
- ⑩ The first step in making a bound buttonhole.



1. Mark the positions of the buttonholes on the fabric.

* The maximum buttonhole length is 3 cm (1-3/16") (total of diameter + thickness of button).

* Thick thread (#30) cannot be used in with the “” and “” patterns.

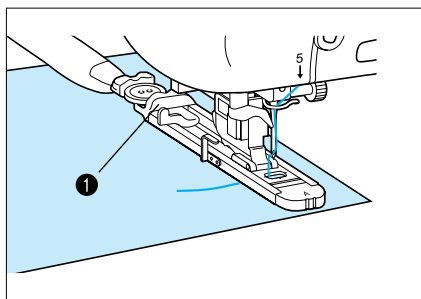

2. Draw out the button holder plate and insert the button.

① Button holder plate

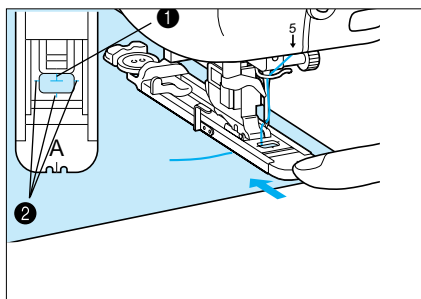

3. Raise the presser foot and adjust the fabric so that the red mark on the foot is over the starting mark of your buttonhole. Lower the presser foot into position.

- ① Mark on fabric for buttonhole position
- ② Red mark on presser foot

* After the presser foot lever has been lowered, set the presser foot so that there is no gap behind the section marked with an “A”, otherwise the size of the stitch will not be correct. To do this, push the presser foot towards the back of the machine as shown in the left figure.

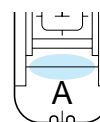

* Pass the thread underneath the presser foot.

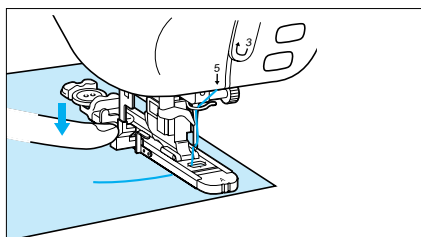

4. Lower the buttonhole lever and position it behind the metal bracket on the buttonhole foot.

① Metal bracket on the buttonhole foot

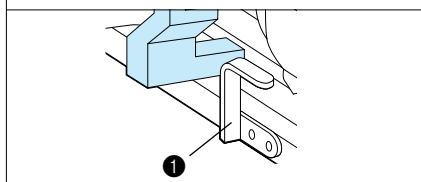

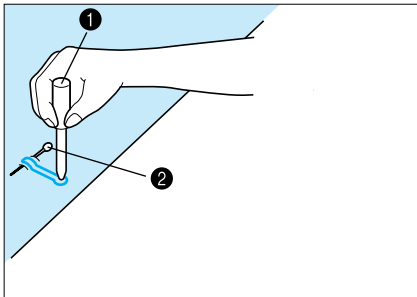
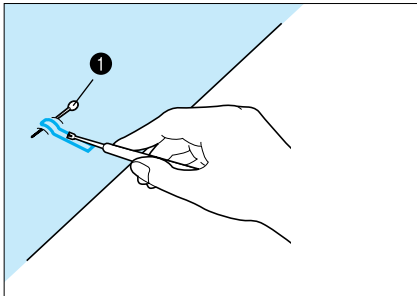
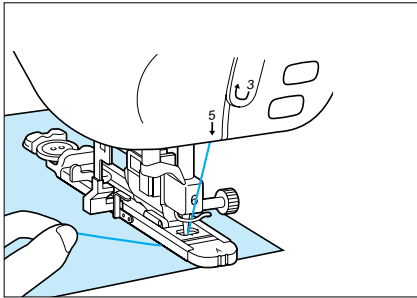

5. Press the “START/STOP” button to start the machine, while gently holding the end of the upper thread.

- * Gently, feed the fabric by hand.
- * The machine will stop with a reinforcement stitch automatically after sewing is completed.
- * If you touch the automatic thread cutting key prior to sewing, the machine cuts both threads automatically after sewing is completed.
- * If the fabric will not feed (for instance, because it is too thick), touch the “▲” stitch length setting key to increase the stitch length.

6. Open the buttonhole.

Normal buttonhole and rounded buttonhole

Insert a pin in front of the inside edge of both bar tacks. Insert the seam ripper into center of buttonhole. Cut towards the first pin. Then cut toward the other pin.

- ① Pin

Keyhole buttonhole

Make a hole using the small eyelet punch in the key end, insert a pin into the inside edge of the bar tack. Insert a seam ripper into the hole made with the eyelet punch and cut towards the pin.

- ① Small eyelet punch (accessory #7 on page 7)
- ② Pin

Order of one cycle

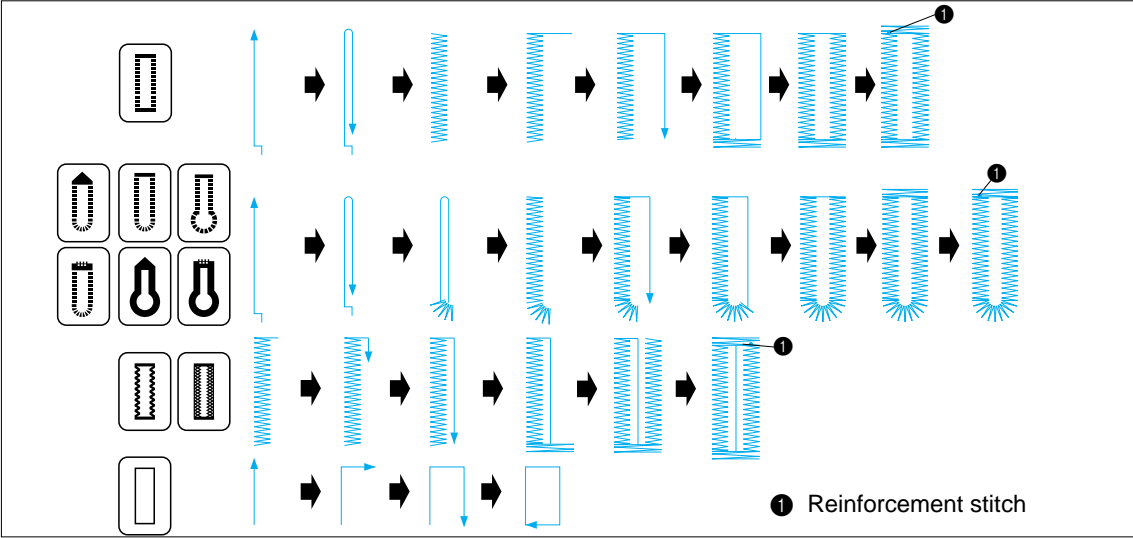

Sewing stretch fabrics

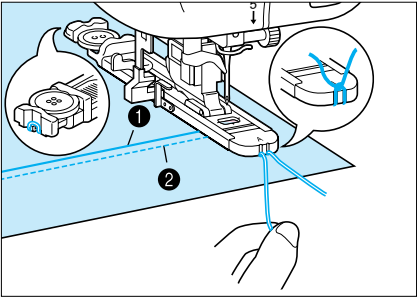

When sewing buttonholes onto stretch fabric, insert onto stretch fabric, a gimp thread into the buttonhole seam ("□" buttonholes only).

1. Hook the gimp thread onto the end of presser foot "A", insert it into the groove at the front of the presser foot and temporarily tie it there.

- ① Upper thread
- ② Bobbin thread

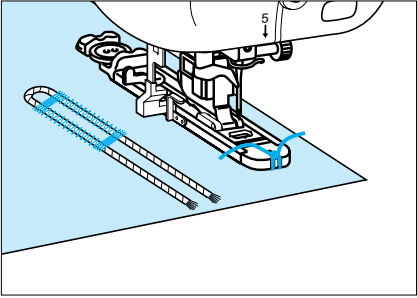

2. Lower the presser foot and start sewing.

* Set the stitch width to match the diameter of the gimp thread.

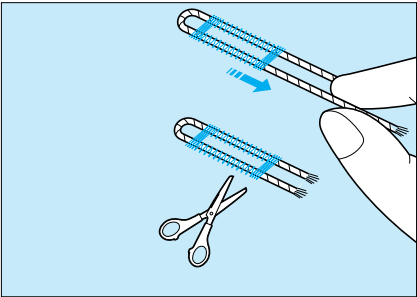

3. Once sewing is completed, pull the gimp thread gently to remove any slack, and trim any surplus length.

Buttons that do not fit into the guide plate (Odd-shaped buttons)

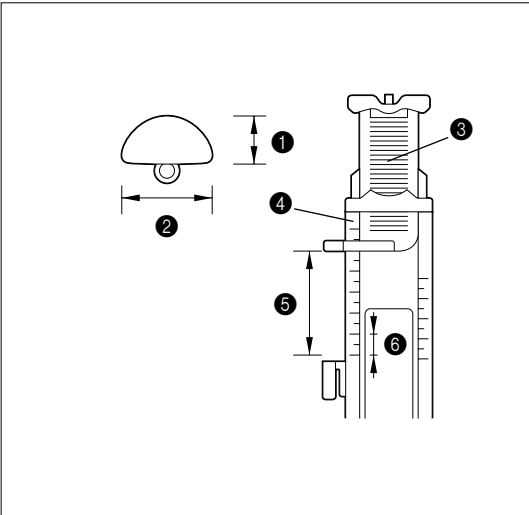

Measure the button diameter + thickness to set the plate.

Example: For a button with a diameter of 1.5 cm (9/16") and a thickness of 1 cm (3/8"), the scale should be set at 2.5 cm (1")

- ① Thickness [1 cm (3/8")]
- ② Diameter [1.5 cm (9/16")]
- ③ Button holder plate
- ④ Scale
- ⑤ Diameter + thickness [2.5 cm (1")]
[0.5 cm (3/16") in one scale.]
- ⑥ 0.5 cm (3/16")

Changing the stitch length

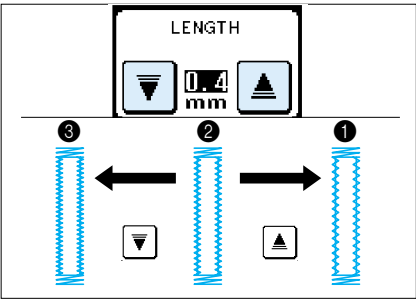

Touch the "▲" and "▼" stitch length setting keys to adjust the stitch length.

- ① "▲": Longer
- ② Normal length 0.4 mm (1/64")
- ③ "▼": Shorter

* If the fabric will not feed (for instance, because it is too thick), touch the "▲" stitch length setting key to increase the stitch length.

Changing the stitch width

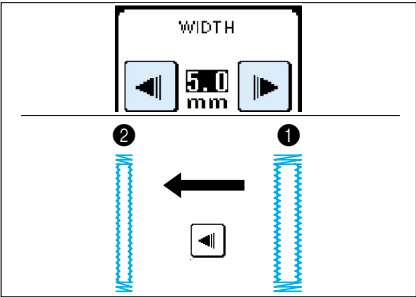

Touch the "◀" and "▶" stitch width setting keys to adjust the stitch width.

- ① "AUTO" width 5.0 mm (3/16")
- ② "◀": Narrower



Use for reinforcing the openings of pockets, etc.

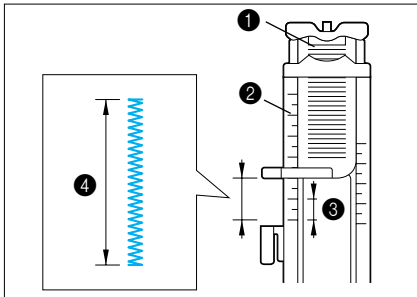

1. Attach presser foot “A” and set the size by measuring the area to be bar tacked.

- ❶ Button holder plate
- ❷ Scale
- ❸ 0.5 cm (3/16")
- ❹ Length of bar tack

* 0.5 to 3 cm (3/16" to 1/2") is suitable for bar tacking. 0.5 to 1 cm (3/16" to 3/18") is the normal size.

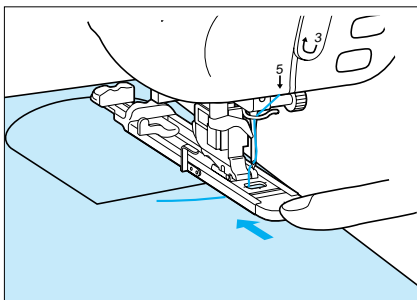

2. Position the pocket as illustrated with the top of the pocket facing you. Stitch down the pocket following the pattern instructions. To secure the pocket with bar tacking align the needle drop point with the corner of the pocket to be stitched and move the pocket back 2 mm (1/16") as shown below.

- * After the presser foot lever has been lowered, set the presser foot so that there is no gap behind the section marked with an “A”, otherwise the size of the stitch will not be correct. To do this, push the presser foot towards the back of the machine as shown in the figure.
- * Pass the thread underneath the presser foot.

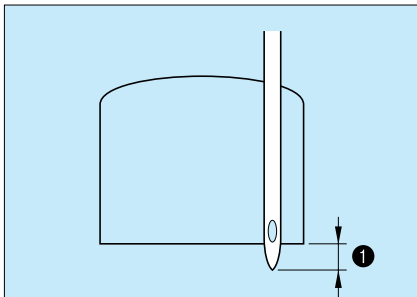
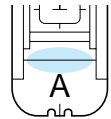

3. Check the first needle drop point and lower the presser foot.

- ❶ 2 mm (1/16")

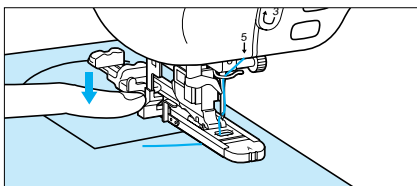

4. Lower the buttonhole lever and position it behind the metal bracket on the buttonhole foot.

- ❶ Metal bracket on buttonhole foot

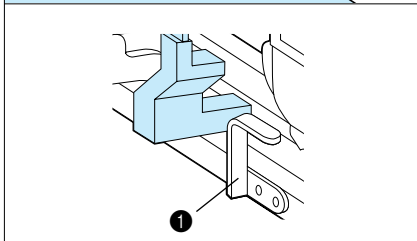

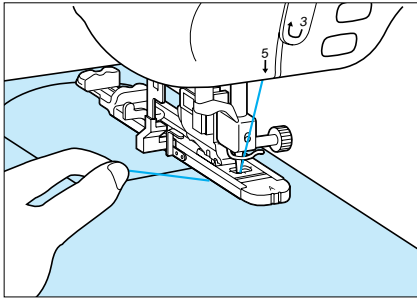

5. Start the machine while holding the end of the upper thread.
- * The machine will sew a reinforcement stitch and stop automatically after sewing is completed.
 - * If you touch the automatic thread cutting key prior to sewing, the machine cuts both threads automatically after sewing is completed.
 - * If the fabric will not feed (for instance, because it is too thick), touch the “▲” stitch length setting key to increase the stitch length.

Thick fabrics

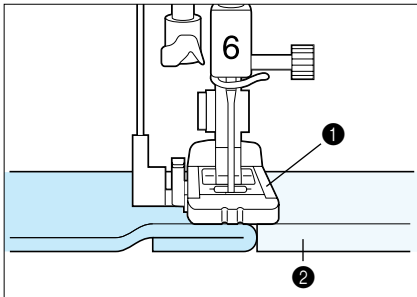

Place another piece of fabric or cardboard at the back as thick as original. This sets the presser foot to the same height and allows for easier feeding.

- ① Presser foot
- ② Cardboard

Changing the bar tack stitch length

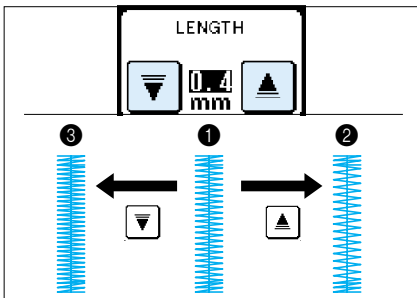

Touch the “▲” and “▼” stitch length setting keys to adjust the stitch length.

- ① “AUTO” length 0.4 mm (1/64”)
- ② “▲” : Longer
- ③ “▼” : Shorter

* If the fabric will not feed (for instance, because it is too thick), touch the “▲” stitch length setting key to increase the stitch length.

Changing the bar tack stitch width

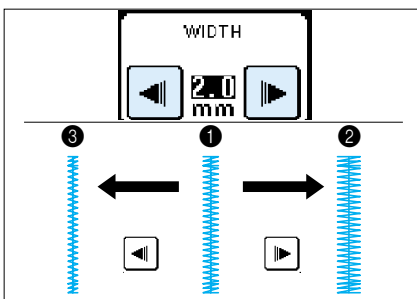

Touch the “◀” and “▶” stitch width setting keys to adjust the stitch width.

- ① “AUTO” width 2.0 mm (1/16”)
- ② “▶” : Wider
- ③ “◀” : Narrower

DARNING



- Setting Up
- Sewing
- Utility Stitches
- Characters and Decorative Stitches
- Embroidering
- Editing Embroidery Patterns
- Retrieving
- My Custom Stitches™
- Maintenance
- Error Messages
- Trouble shooting
- Sewing Chart
- Patterns (Programmed in Machine)
- Patterns (Memory Card)

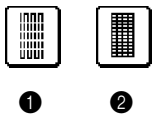

- ① Medium fabric
- ② Thick fabric

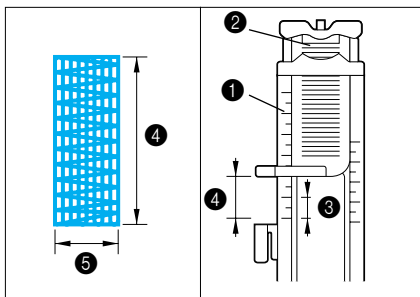

1. Set the stitch length using the scale on presser foot "A".

- ① Scale on the presser foot
- ② Button holder plate
- ③ 5 mm (3/16") at "2" on scale
- ④ Length of darning is equal to scale setting.
- ⑤ Width [7 mm (1/4")]

* The maximum stitch length for darning is 3 cm (1-3/16").

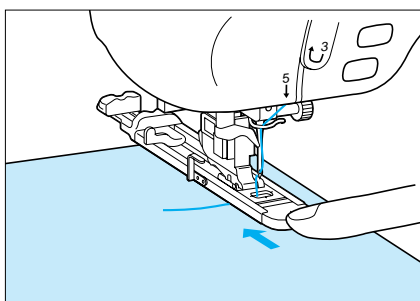

2. Check the needle drop point and then lower the presser foot.

- * After the presser foot lever has been lowered, set the presser foot so that there is no gap behind the section marked with an "A", otherwise the size of the stitch will not be correct. To do this, push the presser foot towards the back of the machine as shown in the left figure.
- * Pass the thread underneath the presser foot.

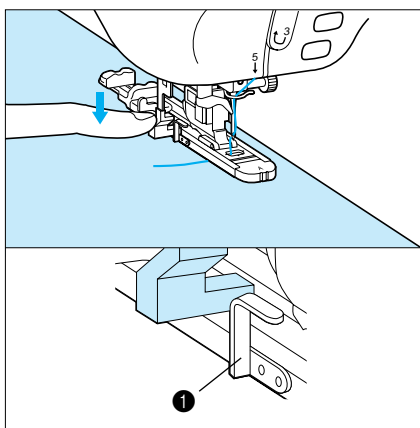
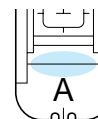

3. Lower the button hole lever to set it behind the metal bracket.

- ① Metal bracket

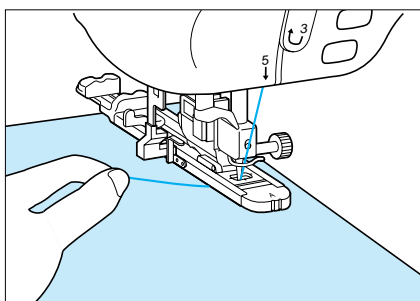

4. Start sewing while holding the upper thread by hand.

- * The machine stops automatically after sewing a reinforcement stitch.
- * When automatic thread cutting is set, the machine trims both threads automatically after sewing is completed.

Changing the length of the darning stitch

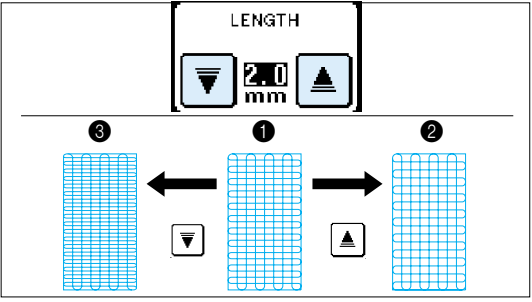

Touch the “▲” and “▼” stitch length setting keys to adjust the stitch length.

- ① “AUTO”: 2.0 mm (1/16”)
- ② “▲”: Longer (less dense)
- ③ “▼”: Shorter (more dense)

* If the fabric will not feed (for instance, because it is too thick), touch the “▲” stitch length setting key to increase the stitch length.

Changing the bar tack stitch width

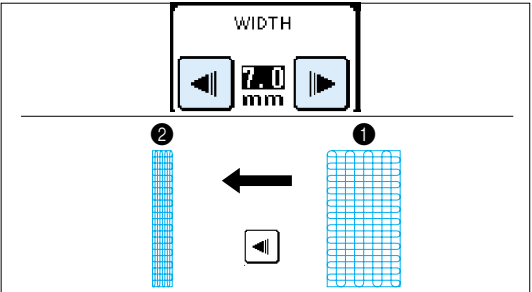

Touch the “◀” and “▶” stitch width setting keys to adjust the stitch width.

- ① “AUTO”: 7.0 mm (1/4”)
- ② “◀”: Narrower

Darning stitch cycle

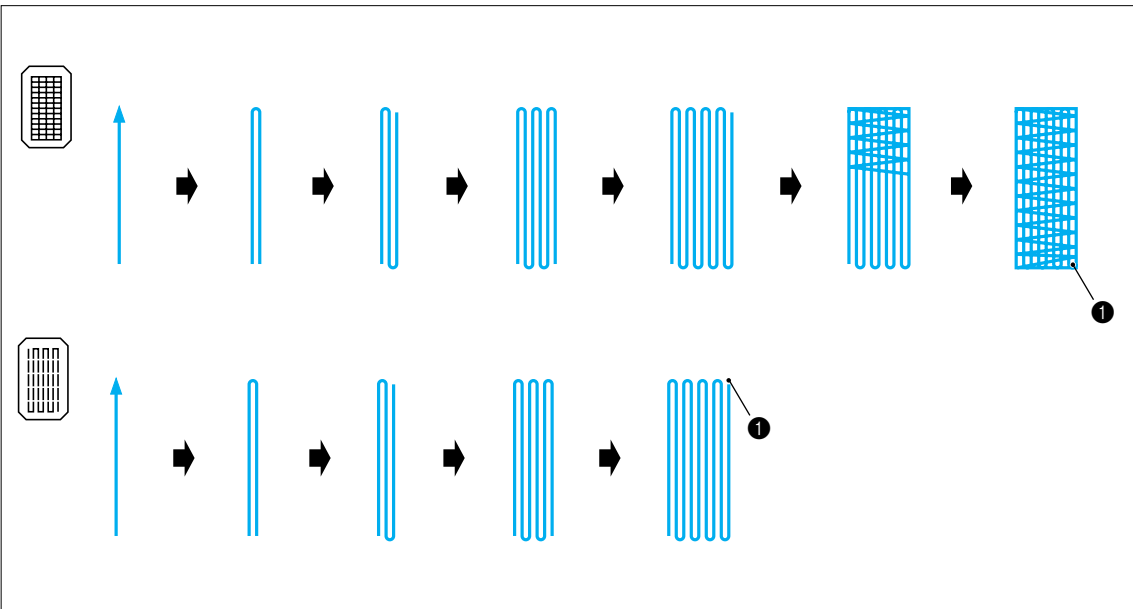

① Reinforcement stitch

TAPE ATTACHING



These stitches are used for attaching tape to thin and medium fabric.



1



2

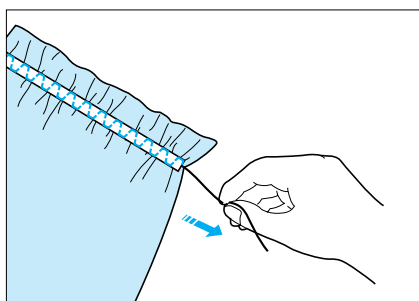
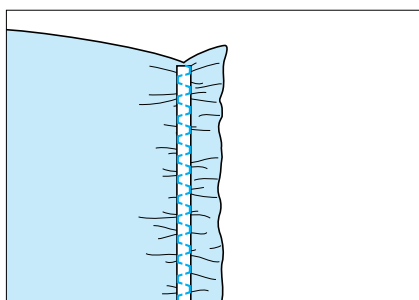
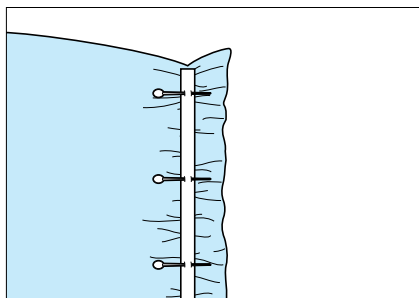
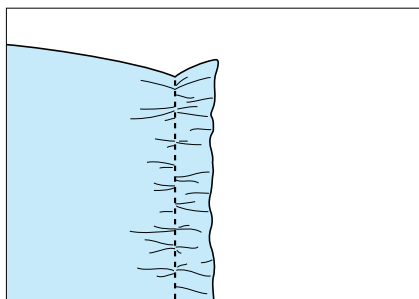

- 1 Patchwork stitch
- 2 Elastic zigzag stitch

1. Attach presser foot “J”, select pattern “”, set the stitch length to 4.0 mm and set the thread tension to a weak setting. Then sew a straight stitch. Pull the bobbin thread to obtain the desired amount of gather.

Note

Before using the basting stitch, rotate the hand wheel and pull up the bobbin thread, grasping the top and bobbin thread pull a length of thread out from the rear of the machine. (Be sure that the presser foot is lifted.)

2. Place the tape on top of the seam which you have just sewn and secure it with pins.

3. Select pattern “” and then sew along the top of the tape.

4. Pull out the straight stitch thread.

Setting Up

Sewing

Utility Stitches

Characters and Decorative Stitches

Embroidering

Editing Embroidery Patterns

Retrieving

My Custom Stitch™

Maintenance

Error Messages

Trouble shooting

Sewing Chart

Patterns (Programmed in Machine)

Patterns (Memory Card)

EYELET STITCH



Stitch for making eyelet on belts, etc.

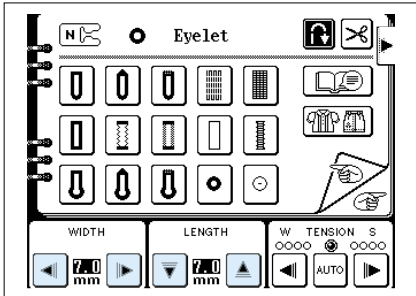

1. Touch the “▲” and “▼” stitch length setting keys and the “▶” and “◀” stitch width setting keys to set the size of the eyelet.

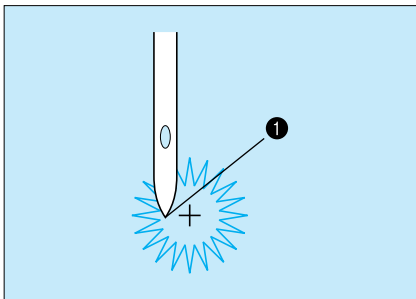

2. Attach presser foot “N”, check the needle drop point and lower the presser foot, then start sewing.

① Needle drop point

- * The machine stops automatically after sewing a reinforcement stitch.
- * When automatic thread cutting is set, the machine trims both threads automatically after sewing is completed.

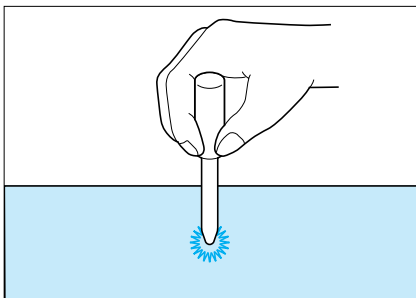

3. Make a hole at the center with an eyelet punch.

Size of eyelet (Actual size)

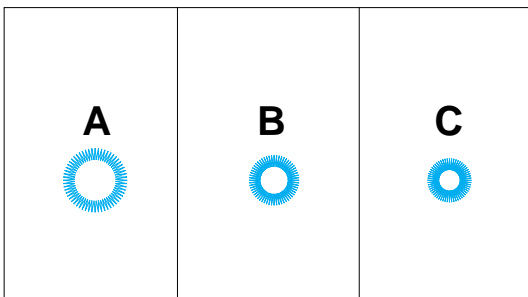

- A– Large: 7.0 mm (5/16")
- B– Medium: 6.0 mm (1/4")
- C– Small: 5.0 mm (3/16")

- Setting Up
- Sewing
- Utility Stitches
- Characters and Decorative Stitches
- Embroidering
- Editing Embroidery Patterns
- Retrieving
- My Custom Stitch™
- Maintenance
- Error Messages
- Trouble shooting
- Sewing Chart
- Patterns (Programmed in Machine)
- Patterns (Memory Card)



This stitch is used for attaching buttons.



Do not use the automatic thread cutter when attaching buttons, (the threads will become difficult to handle and tying off will not be possible).

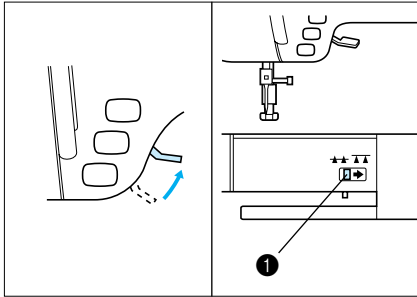

1. Raise the presser foot lever and slide the feed dog adjustment lever to the right to lower the feed dog.

① Feed dog adjustment lever

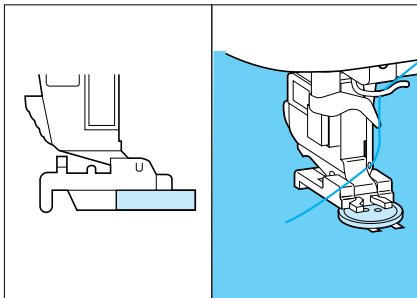

2. Attach button fitting foot "M", place the button into the presser foot and then lower the presser foot.

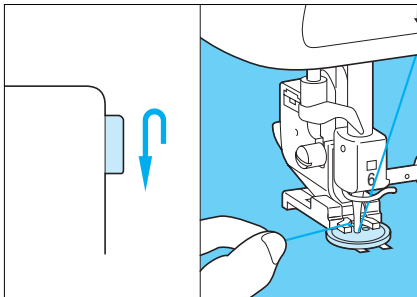

3. Turn the balance wheel to check that the needle goes into each of the holes in the button correctly, and then start sewing. Once sewing is completed, the machine will stop automatically.

* If extra attachment strength is needed, carry out the button sewing operation twice.

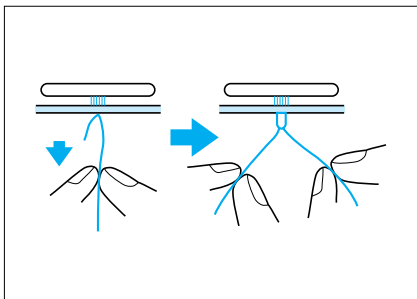

4. Once sewing is completed, return the feed dog to its original position, pull the bobbin thread at the sewing end down and pull the upper thread at the sewing end through to the reverse side of the fabric. Then tie the thread ends together and cut the threads at the sewing start.

Attaching buttons with four holes

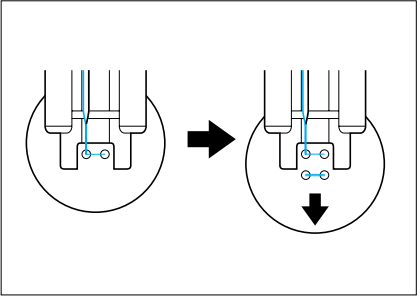

First sew the two holes which are closest to you. Once they have been sewn, raise the presser foot, move the needle to the next two holes and then sew them in the same way.

Attaching a shank to the button

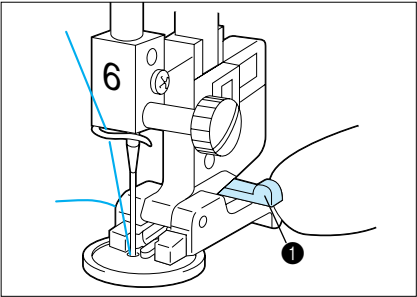

1. Pull the shank lever toward you and then start sewing.

① Shank lever

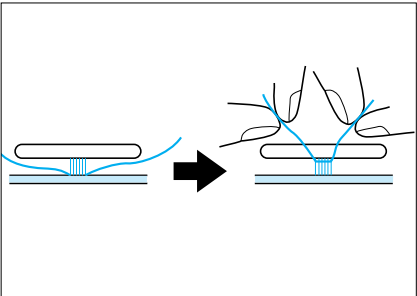

2. Hold the upper thread ends at the sewing start and sewing end which are between the button and the fabric, wind them around the shank and then tie them firmly together.

3. Tie the ends of the bobbin thread together at the reverse side of the fabric.

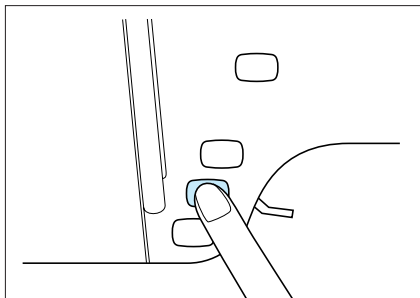

1. Attach presser foot "J". It is suggested that the basting stitch be started with a reinforcement stitch by pressing the "REVERSE STITCH" button.

Note

If you do not want to use a reinforcement stitch at the beginning, you should lift the presser foot, rotate the hand wheel, pull up the bobbin thread and pull a length of top and bobbin thread out from the rear of the machine.

* You can change the length of one stitch to between 5 mm and 30 mm (3/16" to 1-3/16").

- ① 5 mm to 30 mm (3/16" to 1-3/16")

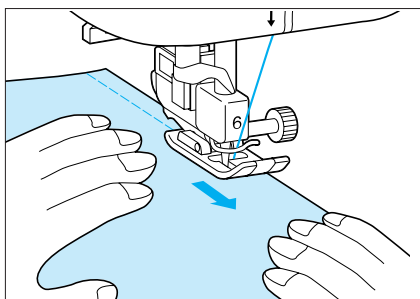
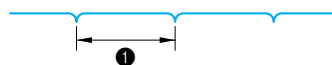

2. Sew while keeping the fabric taut.
3. End sewing with a reinforcement stitch.

ZIPPER INSERTION (CENTERED AND SIDE APPLICATION)



Select the pattern and then touch the “” key.

- Setting Up
- Sewing
- Utility Stitches
- Characters and Decorative Stitches
- Embroidering
- Editing Embroidery Patterns
- Retrieving
- My Custom Stitches™
- Maintenance
- Error Messages
- Trouble shooting
- Sewing Chart
- Patterns (Programmed in Machine)
- Patterns (Memory Card)

Centered application

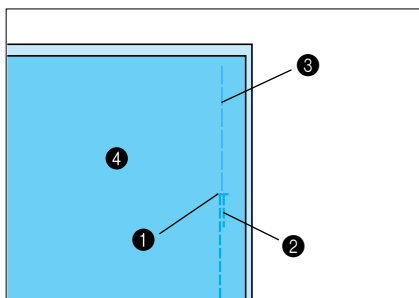

1. Attach presser foot “J” and sew straight stitches up to the crotch end. Change to a basting stitch and sew to the top of the fabric.

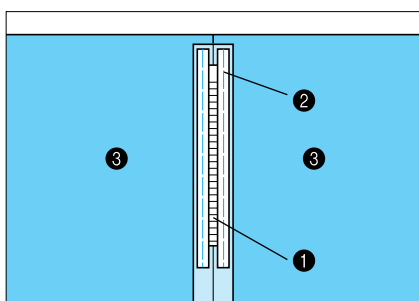

- ① Crotch end
- ② Reverse stitch
- ③ Basting stitch
- ④ Reverse side

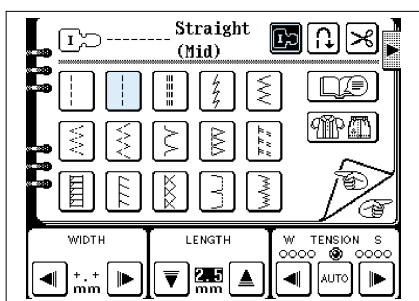

2. Press the seam allowance open and attach the zipper with a basting stitch in the middle.

- ① Zipper
- ② Basting
- ③ Reverse side



3. Select the “” stitch and then touch the “” key. The necessary adjustment for zipper insertion will be carried out automatically.

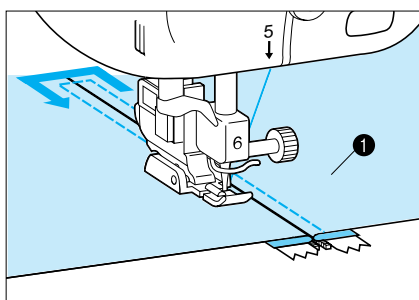

4. Put the right side of presser foot “I” into the holder. Topstitch 1 cm (3/8”) from the seamed edge of the fabric and then remove the basting.

- ① Surface

Side application

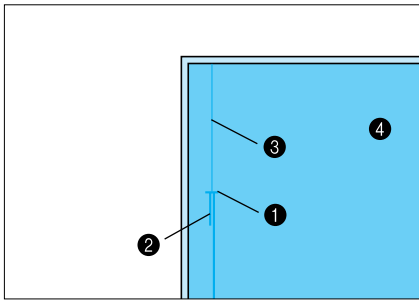

1. Attach presser foot “J” and sew straight stitches up to the crotch end. Change to a basting stitch and sew to the top of the fabric.

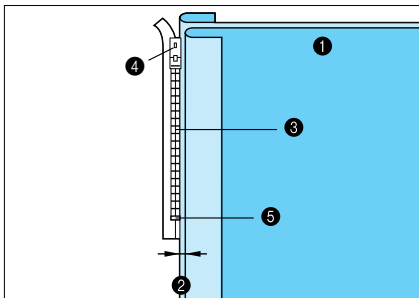

- ① Crotch end
- ② Reverse side
- ③ Basting stitch
- ④ Reverse side

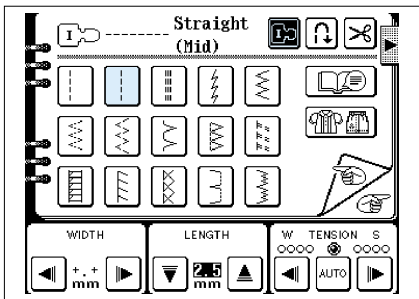

2. Press the seam allowance open and align the folded hem along the teeth of the zipper, while keeping 3 mm (1/8”) for the sewing space.

- ① Reverse side
- ② Keep 3 mm (1/8”) for sewing
- ③ Teeth of zipper
- ④ Slider on head of zipper
- ⑤ Crotch end (Base of zipper)



3. Select the “” stitch and then touch the “” key. The necessary adjustment for zipper insertion will be carried out automatically.

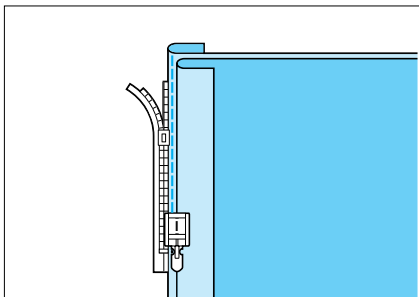

4. Put the left side of presser foot “I” into the holder, and then sew the bottom layer to the crotch end (base of zipper).

* When the automatic thread cutting and automatic reinforcement stitch are preset, reinforcement stitches will be sewn automatically at the start of sewing. Press the “REVERSE STITCH” button to sew a reinforcement stitch and trim the thread automatically at the finish of sewing.

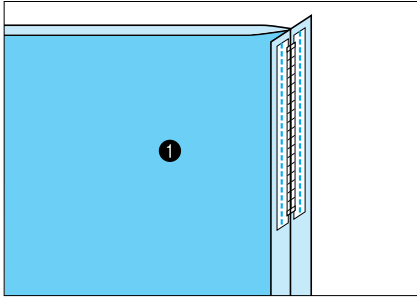

5. Close the zipper and turn over the fabric. Then attach the other side of the zipper to the fabric.

① Reverse side

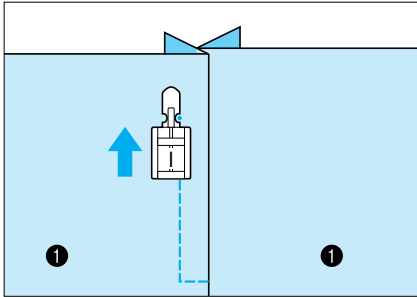

6. Turn the fabric over to the right side and sew a straight stitch 5 cm from the end, stop the machine, lower the needle, raise the presser foot and then remove the basting stitches.

① Surface

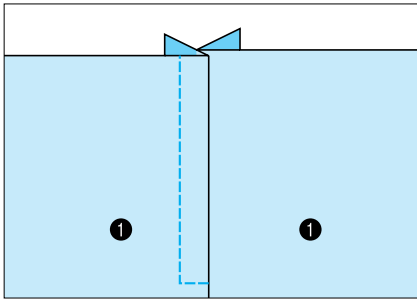

7. Move the zipper pull and sew the remaining part.

① Surface

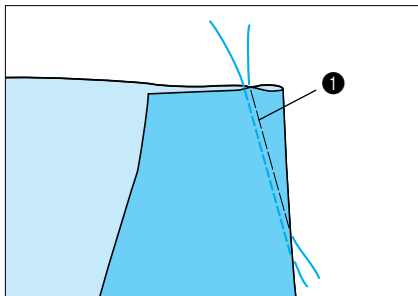

1. Attach presser foot "J". Sew a reverse stitch at the beginning of the dart and then sew from the wide end to the other end without stretching the fabric.

① Basting

* If automatic reinforcement stitching is preset, a reinforcement stitch will automatically be sewn at the sewing start.

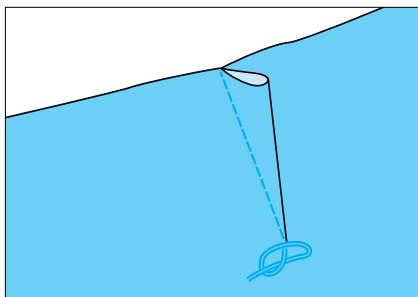

2. Do not sew a reverse stitch at end. Cut the thread at the end leaving 5 cm (1-15/16"), and then tie both ends together.

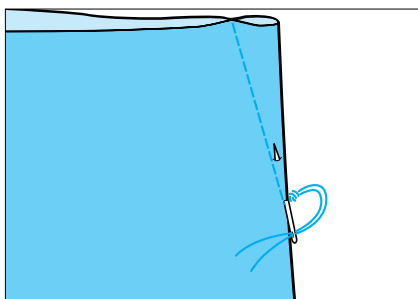

3. Insert the ends of the thread into the dart with a needle.

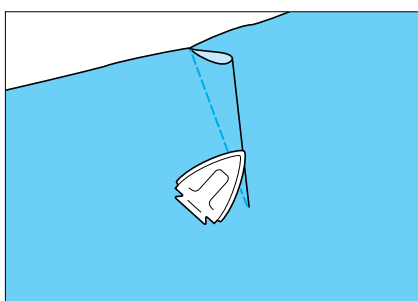

4. Iron the dart to one side so that it is flat.



Use on waists of skirts, the sleeves of shirts, etc.

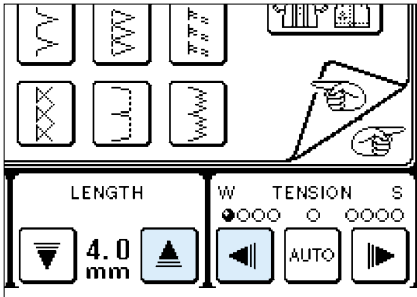

1. Set the stitch length to 4.0 mm (3/16") and the thread tension to weak.

* If you touch the "GATHERING" key after touching the "GATHERING" key, the stitch length will be set automatically to 4.0 mm (3/16") and the thread tension will be set automatically to weak.

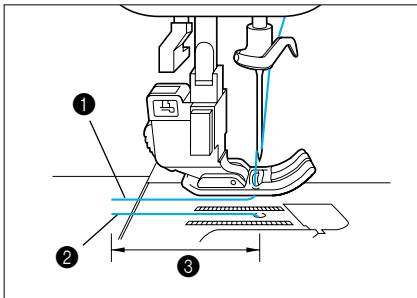

2. Attach presser foot "J". Pull out the bobbin and upper threads by 5 cm (1-15/16").

- ① Upper thread
- ② Bobbin thread
- ③ About 5 cm (1-15/16")

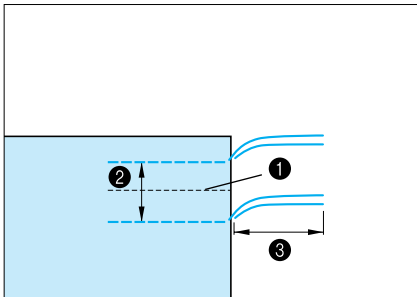

3. Sew two rows of straight stitches parallel to the seam line, then trim excess thread leaving 5 cm (1-15/16").

- ① Seam line
- ② 1.0 to 1.5 cm (3/8" to 9/16")
- ③ About 5 cm (1-15/16")

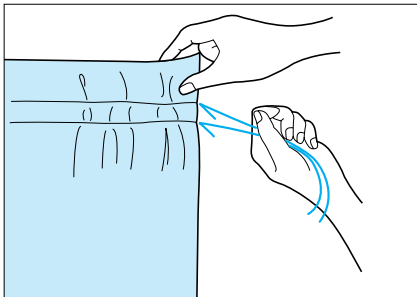

4. Pull the bobbin threads to obtain the desired amount of gather, then tie the threads.

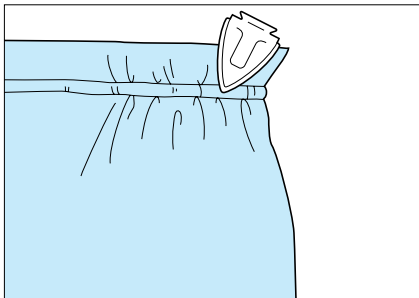

5. Smooth the gathers by ironing them.

Pulling out the bobbin thread

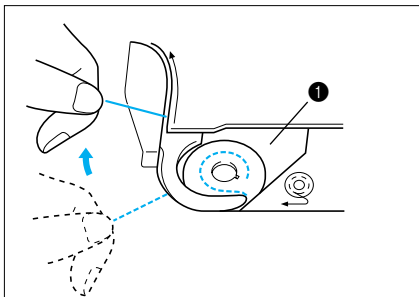

1. Thread the thread along the groove in the direction of the arrow, and leave it there without cutting it.

① Shuttle

* The bobbin cover should still be removed.

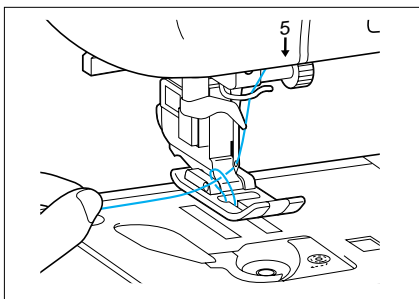

2. While holding the upper thread, press the “NEEDLE POSITION” button twice and then pull out the bobbin thread.

3. Replace the bobbin cover.

PINTUCK



- Setting Up
- Sewing
- Utility Stitches
- Characters and Decorative Stitches
- Embroidering
- Editing Embroidery Patterns
- Retrieving
- My Custom Stitch™
- Maintenance
- Error Messages
- Trouble shooting
- Sewing Chart
- Patterns (Programmed in Machine)
- Patterns (Memory Card)



Select the “” stitch and then touch the “” key.

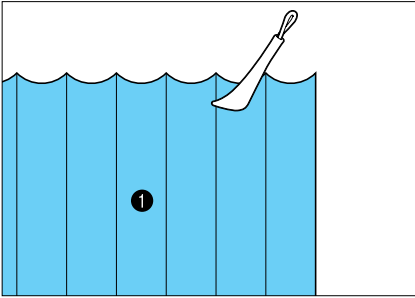

1. Mark along the folds on the reverse side of the fabric.

① Reverse side

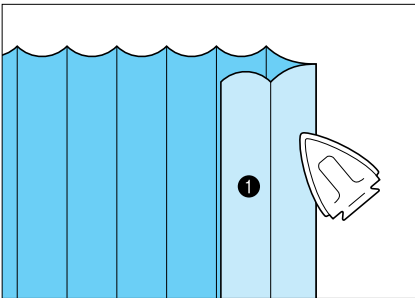

2. Turn the fabric and iron the folded parts only.

① Surface

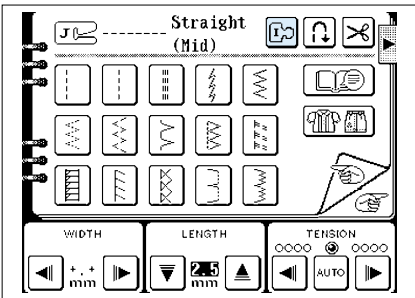

3. Select the “” stitch and then touch the “” key.

* It will not be necessary to adjust the thread tension if pintucking is selected by pressing the “” key.

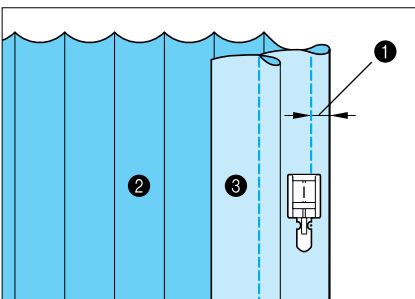

4. Put the right end of presser foot “1” into the holder, and sew a straight stitch along the fold.

- ① Width for pintuck
- ② Reverse side
- ③ Surface

* When the automatic thread cutting and automatic reinforcement stitch are preset, reinforcement stitches will be sewn automatically at the start of sewing. Press the “REVERSE STITCH” button to sew a reinforcement stitch and trim the thread automatically at the finish of sewing.

5. Iron the folds toward the same direction.

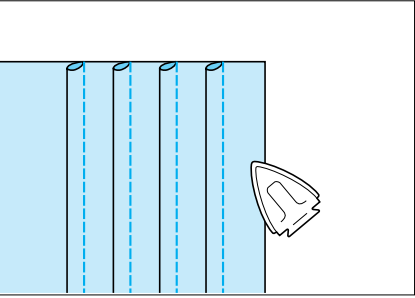

FLAT FELL SEAM



Use for reinforcing seams and finishing edges neatly.

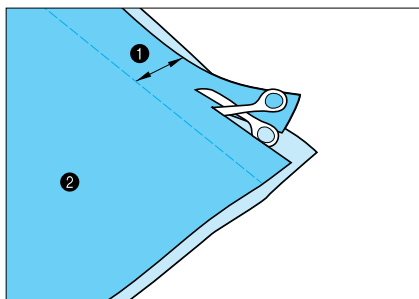

1. Attach presser foot "J". Sew the finish line, then cut half of the seam allowance from the side that the flat fell seam will lie.

- ① About 1.2 cm (1/2")
- ② Reverse side

* When the automatic thread cutting and automatic reinforcement stitch are preset, reinforcement stitches will be sewn automatically at the start of sewing. Press the "REVERSE STITCH" button to sew a reinforcement stitch and trim the thread automatically at the finish of sewing.

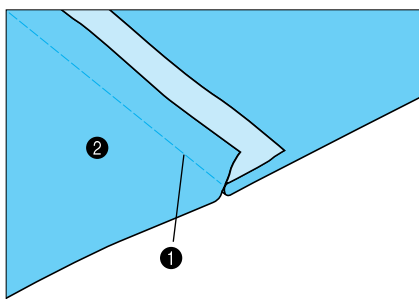

2. Spread out the fabric along the finish line.

- ① Finish line
- ② Reverse side

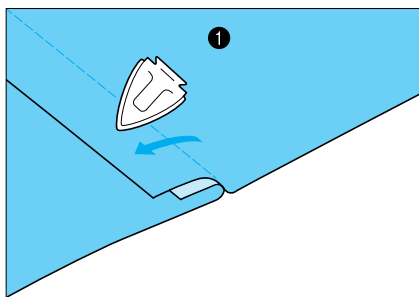

3. Press both seam allowances toward the more narrow (cut one) side and iron them.

- ① Reverse side

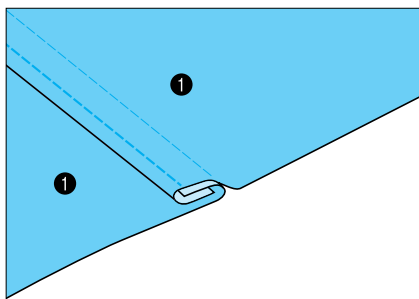

4. Fold the longer seam allowance around more narrow one, and sew the edge of the fold.

- ① Reverse side

Setting Up

Sewing

Utility Stitches

Characters and Decorative Stitches

Embroidering

Editing Embroidery Patterns

Retrieving

My Custom Stitch™

Maintenance

Error Messages

Trouble shooting

Sewing Chart

Patterns (Programmed in Machine)

Patterns (Memory Card)

Finished flat fell seam

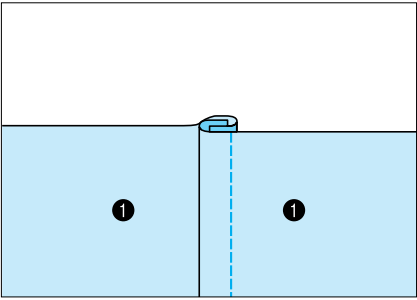

1 Surface

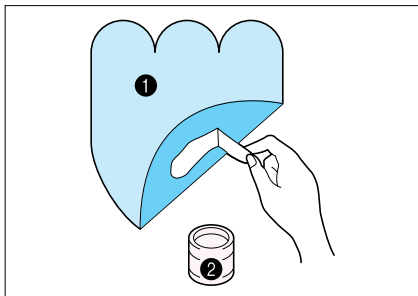

1. Attach the applique to the fabric.

- ① Applique
- ② Fabric glue

* The applique should be attached with fabric glue or a basting stitch so that it will not move during sewing.

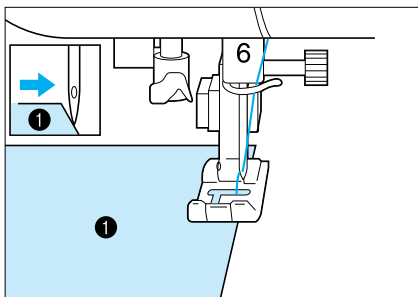

2. Attach presser foot “J”. Make sure that the needle drop point is just outside the applique and then start sewing.

- ① Applique

* When the automatic thread cutting and automatic reinforcement stitch are preset, reinforcement stitches will be sewn automatically at the start of sewing. Press the “REVERSE STITCH” button to sew a reinforcement stitch and trim the thread automatically at the finish of sewing.

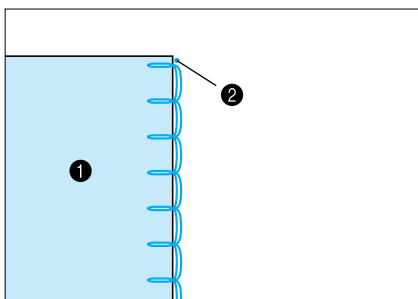

3. Finish

- ① Applique
- ② Needle drop point

Sewing the applique around corners

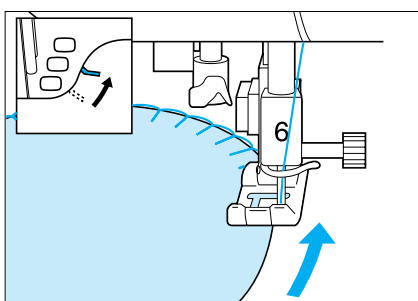

1. Stop the machine and position the needle just outside the applique.

2. Raise the presser foot and turn the fabric as needed to keep the correct needle position.



Use a blind hem stitch for applique quilts.

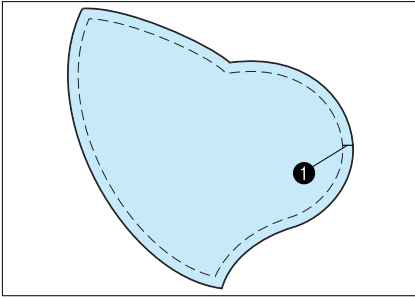

1. Trace the pattern onto the applique fabric and then cut around it.

① Seam margin (0.3 to 0.5 mm)

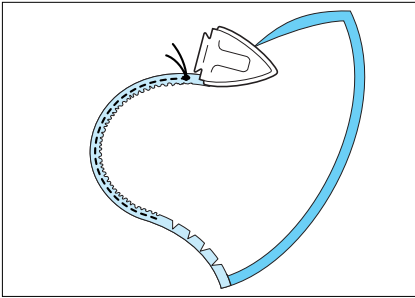

2. Place a piece of thick paper cut to the finished size onto the fabric, and then fold over the seam margin using an iron.

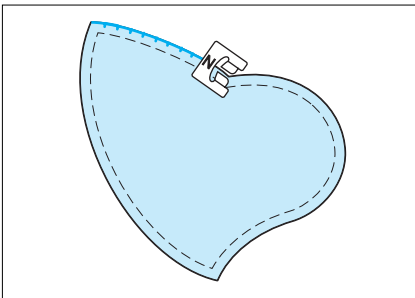

3. Turn the fabric over and sew basting stitches around the edge. Attach monogramming foot "N" and then sew around the edge, while dropping the needle as close to the edge as possible.

* When the automatic thread cutting and automatic reinforcement stitch are preset, reinforcement stitches will be sewn automatically at the start of sewing. Press the "REVERSE STITCH" button to sew a reinforcement stitch and trim the thread automatically at the finish of sewing.

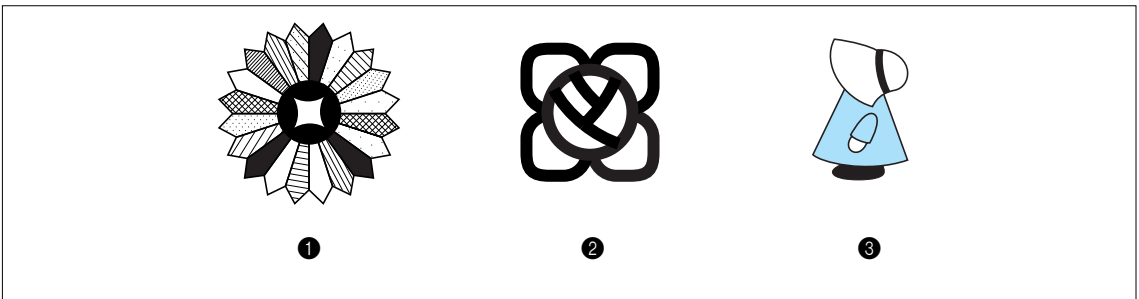

- ① Dresden Plate
- ② Stained Glass
- ③ Sunbonnet Sue

SCALLOP STITCH



Stitch for decorating collars of blouses, edges of table cloths, etc.

3

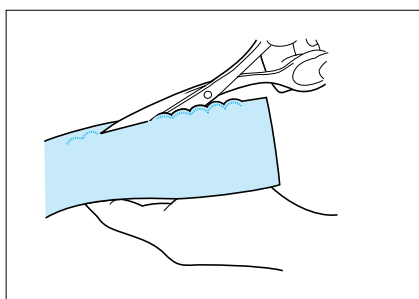
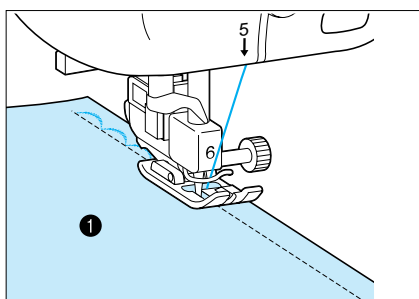

1. Attach presser foot "N". Sew the remaining edge of the fabric so that the stitch doesn't go right to the edge of the fabric.

① Surface

* When the automatic thread cutting and automatic reinforcement stitch are preset, reinforcement stitches will be sewn automatically at the start of sewing. Press the "REVERSE STITCH" button to sew a reinforcement stitch and trim the thread automatically at the finish of sewing.

2. Trim along the stitches carefully so as not to cut the stitches.

* There are products in the marketplace that will "seal" the trimmed areas. This will give a more finished appearance.

Setting Up

Sewing

Utility
Stitches

Characters
and
Decorative
Stitches

Embroidering

Editing
Embroidery
Patterns

Retrieving

My
Custom
Stitch™

Maintenance

Error
Messages

Trouble
shooting

Sewing
Chart

Patterns
(Programmed
in Machine)

Patterns
(Memory
Card)

SMOCKING STITCH



This stitch is used for decorative stitching on clothing.

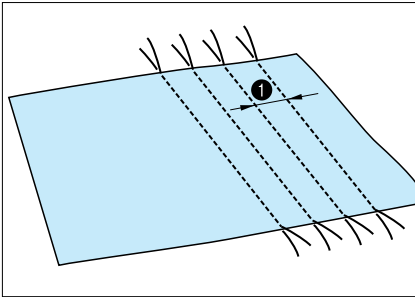
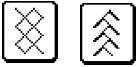

1. Select the “” stitch, set the stitch length to 4.0 mm and set the thread tension to a weak setting. Then sew straight stitches at intervals of 1 cm.

① About 1 cm (3/8”)

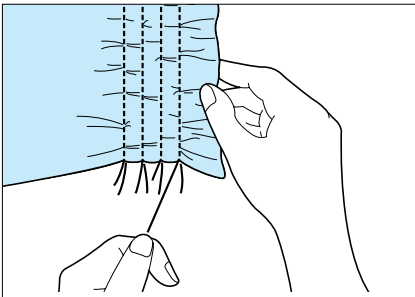

2. Pull the bobbin threads to obtain the desired amount of gather, and then smooth the gathers by ironing them.

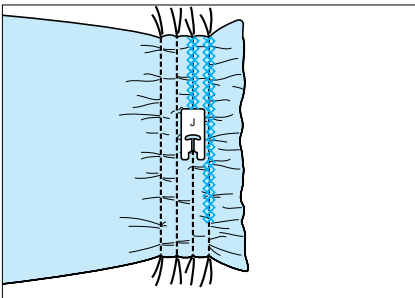

3. Attach presser foot “J” and sew over the top of the straight stitches, selecting from one of the two decorative stitches shown above.

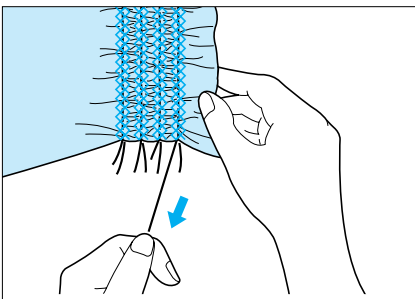

4. Pull out the straight stitch threads.

Setting Up

Sewing

Utility Stitches

Characters and Decorative Stitches

Embroidering

Editing Embroidery Patterns

Retrieving

My Custom Stitch™

Maintenance

Error Messages

Trouble shooting

Sewing Chart

Patterns (Programmed in Machine)

Patterns (Memory Card)

PATCHWORK STITCH



Setting Up

Sewing

Utility Stitches

Characters and Decorative Stitches

Embroidering

Editing Embroidery Patterns

Retrieving

My Custom Stitch™

Maintenance

Error Messages

Trouble shooting

Sewing Chart

Patterns (Programmed in Machine)

Patterns (Memory Card)

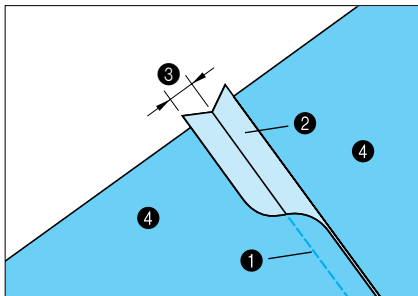

1. Match the fabric seams right sides together, join together with a straight stitch. Open seam allowance [about 1 cm (3/8")] and press flat.

- ① Straight stitch
- ② Seam allowance
- ③ 1 cm (3/8")
- ④ Reverse side

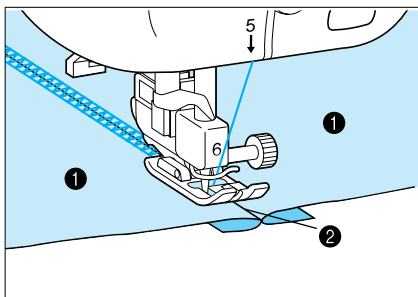

2. Attach presser foot "J". Set the center of the presser foot on the seam lines of the joined fabrics and then sew over the seam, using one of the decorative stitches shown above.

- ① Surface
- ② Seam



Stitch for fagoting, decoration, etc.

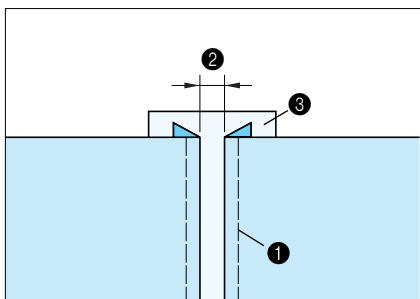

1. Baste the fabric onto thin paper or water-soluble stabilizer sheet.

- ① Basting stitch
- ② 0.4 cm (3/16")
- ③ Thin paper or stabilizer sheet

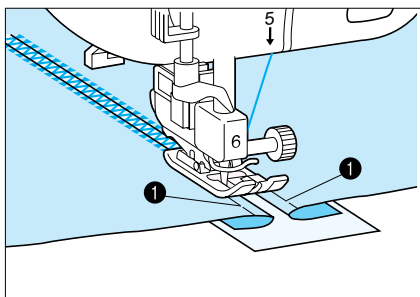

2. Attach presser foot "J". Center the presser foot on the paper between the folded edges of fabric and begin sewing.

- ① Basting stitch
- * Use thick thread. (#30)
- * After sewing, remove the paper.

Setting Up

Sewing

Utility
Stitches

Characters
and
Decorative
Stitches

Embroidering

Editing
Embroidery
Patterns

Retrieving

My
Custom
Stitch™

Maintenance

Error
Messages

Trouble
shooting

Sewing
Chart

Patterns
(Programmed
in Machine)

Patterns
(Memory
Card)



Select the stitch you would like to use.



Decorative stitching

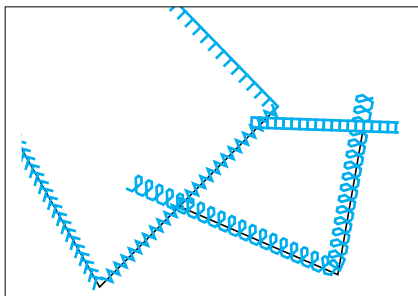

These stitches are used for sewing crazy quilts and for decorating hems.

Shell tacking

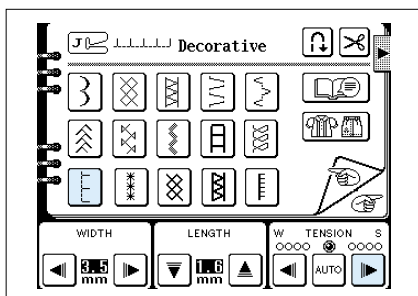

1. Attach presser foot "J", select " " and set the thread tension to a strong setting.

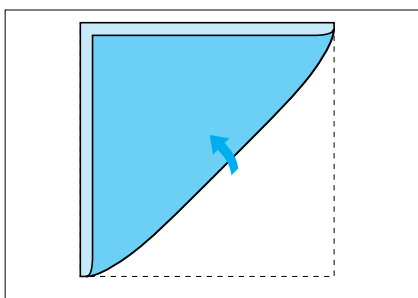

2. Fold the fabric in half diagonally.

* Use a thin fabric.

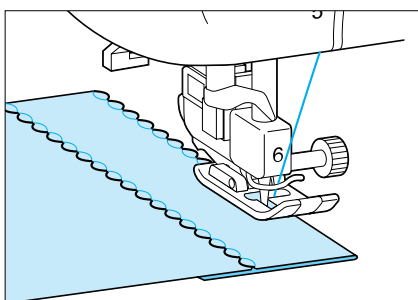

3. Drop the needle slightly to the outside of the edge of the fabric, and then start sewing.

4. Open out the fabric and iron the fold down to one side.

HEM-STITCH (HEIRLOOM STITCH)

Use for sewing tablecloths, decorative hems on clothes and decorative stitching on shirt fronts.



A more attractive finish can be obtained if you use the "130/705H Wing" needle when sewing these patterns. If using a wing needle and the stitch width has been set to manually, check that the needle will not touch the presser foot before starting sewing by carefully rotating the balance wheel.

"E" hem-stitching

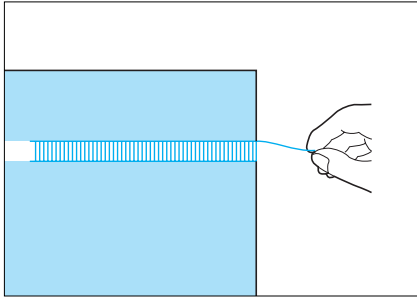

1. Pull out several threads from one area on a piece of fabric. This will leave the fabric frayed in this one area. About 5 or 6 threads will leave a 3 mm (1/8") area.

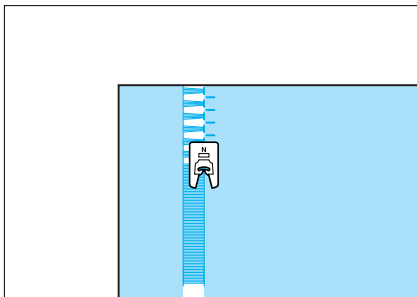

2. Attach presser foot "N". With the reverse side of the fabric facing up, sew one edge of the frayed part.

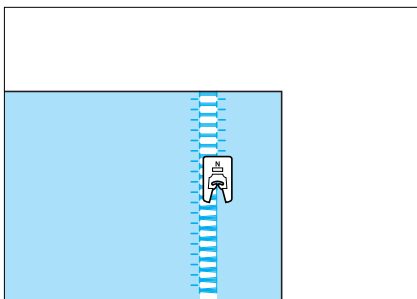

3. With the back side of the fabric continuing to face you, turn the fabric and sew the other edge of the frayed part, aligning the stitches so they are parallel.

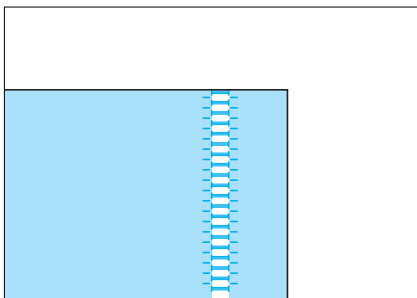

4. Illustration of finished product.

“” hem-stitching

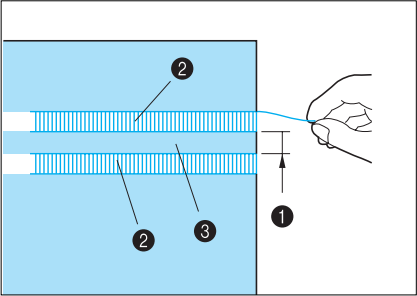

1. Pull out several threads from both sides of the 4 mm (3/16") part which is not yet frayed.
 [Pull out four threads, leave five threads and then pull out four threads, the width of five threads is approximately 4mm (3/16") or less.]

- ① Approx. 4.0 mm (3/16") or less.
- ② Four threads (Pull out)
- ③ Five threads (Leave)

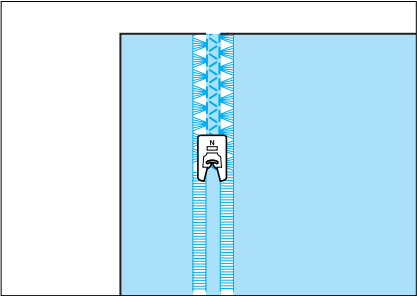

2. Sew the decorative stitch on the center of the five threads created above.

* Wing needle is a option.

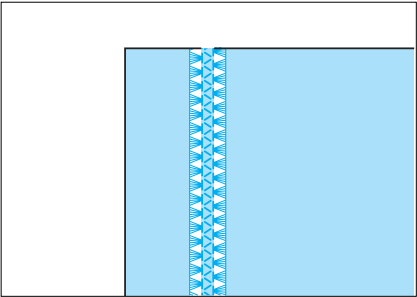





3. Illustration of finished product.

LATERAL SEWING (STRAIGHT/ZIGZAG)

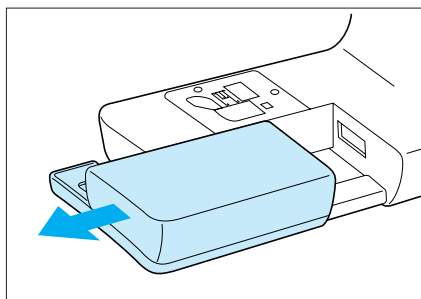

Multi-directional sewing on tubular fabrics.



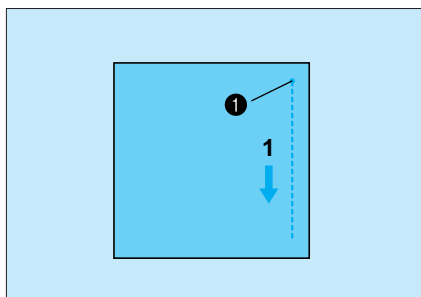
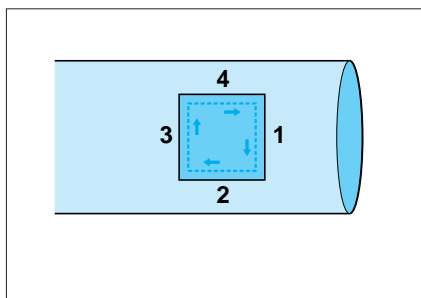

“”, “”, “” and “” can also be used to sew diagonally.
Slide the flat bed attachment off the machine to create the free arm.



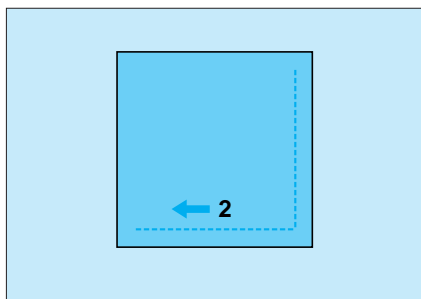

1. Attach presser foot “N”. Sew with the “” stitch to the point required.

1 Start point

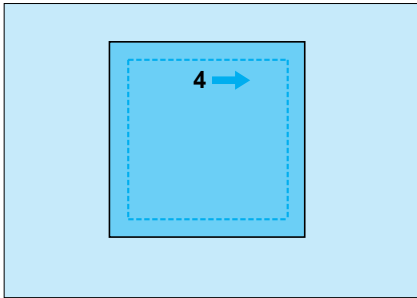
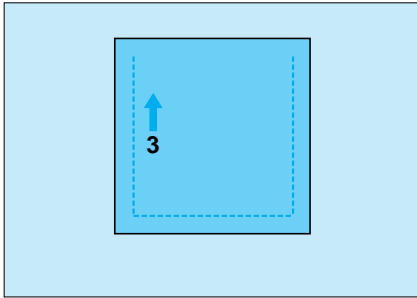

2. Select the “” stitch, and then sew until you reach the desired length.



3. Select the “” stitch again, and press the “REVERSE STITCH” button.

4. Select the “”stitch, and then sew until you reach the starting point.

* Lateral zigzag sewing should be carried out using the same procedure as lateral straight sewing.

3. CHARACTERS AND DECORATIVE STITCHES

CHARACTER SEWING

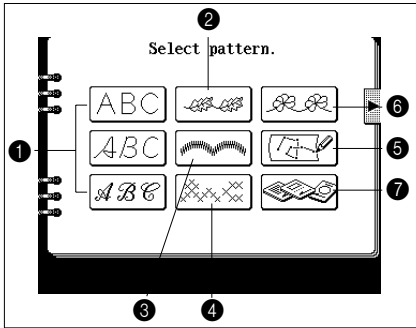

1. Touch the “CHARACTER/DECORATIVE STITCH” key.

- ❶ Alphabetical characters
- ❷ Decorative stitch
- ❸ Satin stitch
- ❹ Cross stitch
- ❺ MY CUSTOM STITCH™ (Function for creating your own stitches)
- ❻ Decorative stitch (7 mm width)
- ❼ Card

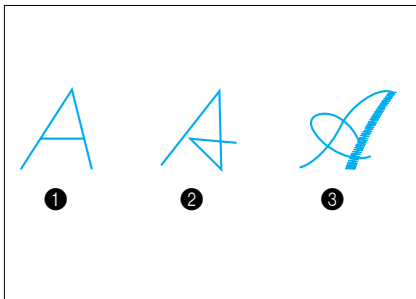

2. Select the style.

- ❶ Block style
- ❷ Alphabet
- ❸ Italic style

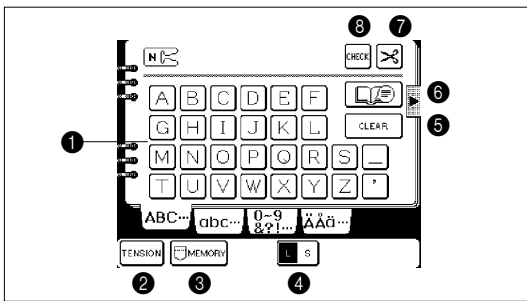

- ❶ Character selection keys
- ❷ Touch this key to change the thread tension.
- ❸ Touch this key to save a pattern combination to memory. (Refer to page 100.)
- ❹ Touch this key to change the character size. (Refer to page 94.)

“L”: Larger
“S”: Smaller

- ❺ Touch this key to cancel your last entry.
- ❻ An advice screen will appear if you touch this key while sewing. (Refer to page 42.)
- ❼ Touch this key to cut the thread automatically after sewing is completed. (Refer to page 39.)
- ❽ Touch this key to confirm your entry. (Refer to page 100.)



Combinations of characters

Try entering “Bus”.

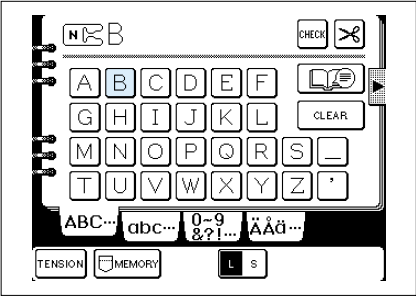

1. Touch “B”.
- * If you select the wrong character by mistake, touch the “CLEAR” key to clear the character selection.

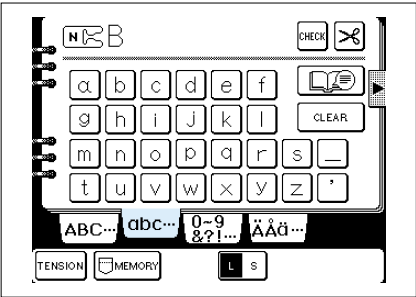

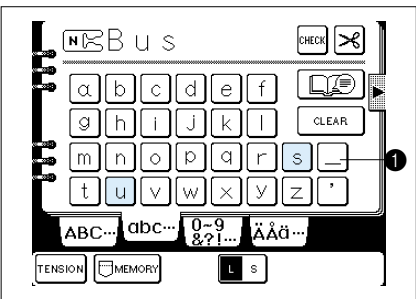

2. Touch “abc. . .” to switch to lower-case.

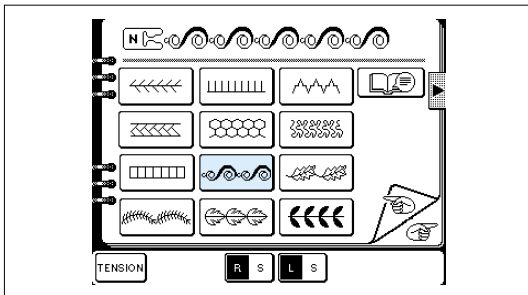
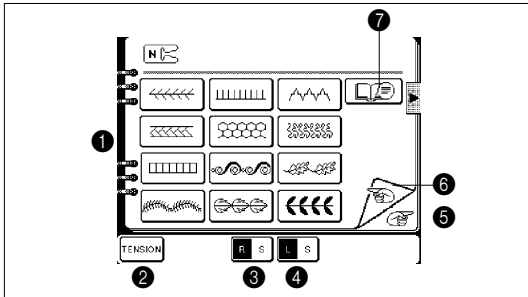
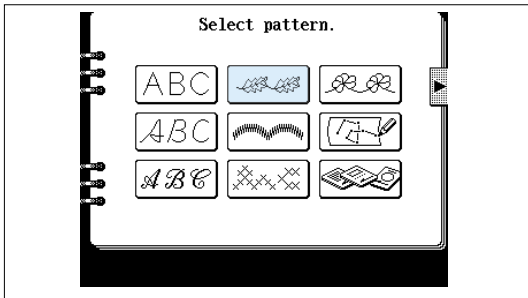

3. Touch “u” and “s”.
- * Any combination of 70 characters or spaces can be accepted at one time.
- ① Space key

DECORATIVE STITCHES



1. Touch the “CHARACTER/DECORATIVE STITCH” key.
2. Touch the “” key.
The decorative stitch pattern selection screen will be displayed.

- 1 Pattern selection keys
- 2 Touch this key to change the thread tension.
- 3 Touch this key to select single or repeat sewing. (Refer to page 94.)
- 4 Touch this key to change the pattern size. (Refer to page 94.)
- 5 Touch this key to move to the next screen.
- 6 Touch this key to return to the previous screen.
- 7 An advice screen will appear if you touch this key while sewing. (Refer to page 42.)

3. Select the pattern.

* Touch the “” key to display the next decorative stitch pattern selection screen.

Setting Up

Sewing

Utility Stitches

Characters and Decorative Stitches

Embroidering

Editing Patterns

Retrieving

My Custom Stitch™

Maintenance

Error Messages

Trouble shooting

Sewing Chart



Patterns (Programmed in Machine)

Patterns (Memory Card)

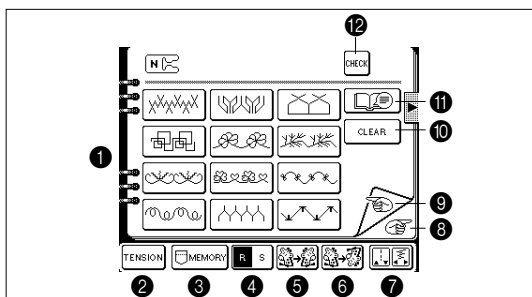
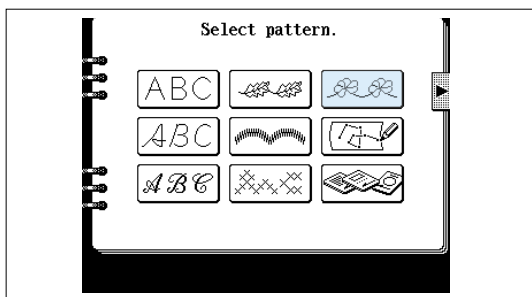
DECORATIVE STITCHES (7 mm)



1. Touch the “CHARACTER/DECORATIVE STITCH” key.
2. Touch the “” key.
The decorative stitch pattern selection screen will be displayed.

- 1 Pattern selection keys
- 2 Touch this key to change the thread tension
- 3 Touch this key to save a pattern combination to memory. (Refer to page 100)
- 4 Touch this key to select single or repeat sewing. (Refer to page 94)
- 5 Touch the  key to reverse the pattern horizontally.
- 6 Touch the  key to reverse the pattern vertically.
- 7 Touch this key to adjust the stitch width and stitch length.
- 8 Touch this key to move to the next screen.
- 9 Touch this key to move to the previous screen.
- 10 Touch this key to cancel your entry.
- 11 An advice screen will appear if you touch this key while sewing. (Refer to page 42)
- 12 Touch this key to confirm your entry. (Refer to page 100)

SATIN STITCHES

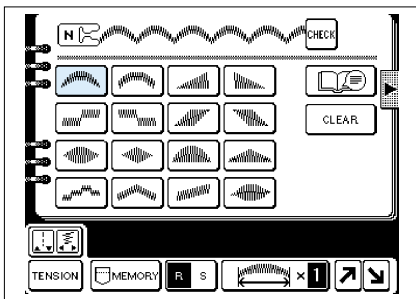
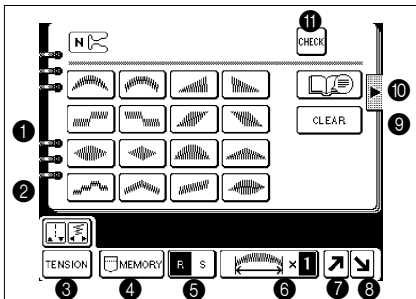
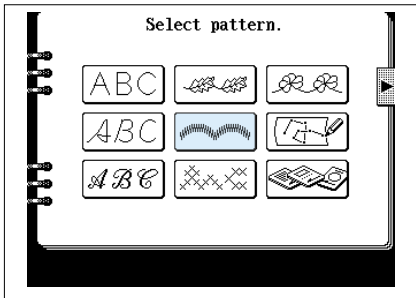

1. Touch the “CHARACTER/DECORATIVE STITCH” key.
The different types of patterns available will be displayed.

2. Touch the “” key.
The satin stitch selection screen will be displayed.

* The thread may easily become knotted when certain types of fabric or thread are used; therefore, the feed should be adjusted according to the application.

- ① Pattern selection keys
- ② Touch this key to adjust the stitch width and stitch length settings.
- ③ Touch this key to change the thread tension.
- ④ Touch this key to save a pattern combination to memory. (Refer to page 100.)
- ⑤ Touch this key to select single or repeat sewing. (Refer to page 89.)
- ⑥ Touch this key if you would like to change the pattern length without changing the stitch width or stitch length settings. (Refer to page 95.)
- ⑦ Touch this key to move the pattern up by about half of it's finished height when sewing. (Refer to page 97.)
- ⑧ Touch this key to move the pattern down by about half of it's finished height when sewing. (Refer to page 97.)
- ⑨ Touch this key to cancel your entry.
- ⑩ An advice screen will appear if you touch this key while sewing. (Refer to page 42.)
- ⑪ Touch this key to confirm your entry. (Refer to 100.)

3. Touch the pattern that you would like to use. The pattern you touch will then be selected for use.

* If you select the wrong pattern by mistake, touch the “CLEAR” key to clear the pattern selection.

* Up to 70 different patterns can be combined into a single pattern.

Setting Up
Sewing
Utility Stitches
Characters and Decorative Stitches
Embroidering
Editing Patterns
Retrieving
My Custom Stitches™
Maintenance
Error Messages
Trouble shooting
Sewing Chart
Patterns (Programmed in Machine)
Patterns (Memory Card)

CROSS STITCHING

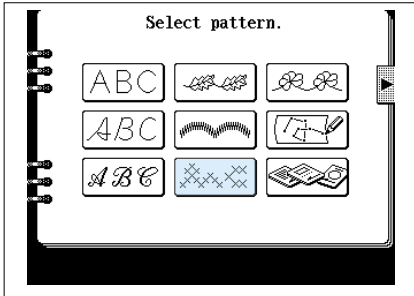

1. Touch the "CHARACTER/DECORATIVE STITCH" key. The different types of patterns available will be displayed.
2. Touch the "☒" key. The cross stitch selection screen will be displayed.

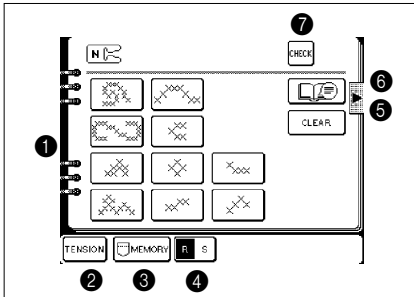

- 1 Pattern selection keys
- 2 Touch this key to change the thread tension.
- 3 Touch this key to save a pattern combination to memory. (Refer to page 100.)
- 4 Touch this key to select single or repeat sewing. (Refer to page 94.)
- 5 Touch this key to cancel your entry.
- 6 An advice screen will appear if you touch this key while sewing. (Refer to page 42.)
- 7 Touch this key to confirm your entry. (Refer to page 100.)

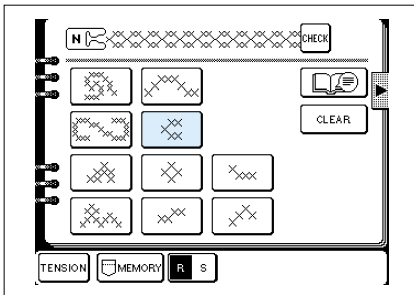

3. Touch the pattern that you would like to use. The pattern you touch will then be selected for use.
- * If you select the wrong pattern by mistake, touch the "CLEAR" key to clear the pattern selection.
 - * Up to 70 different patterns can be combined into a single pattern.

CHARACTER AND DECORATIVE STITCH ADJUSTMENT

Changing the pattern size (Actual size)



Touch the “**L S**” (large/small) key to change the pattern size.

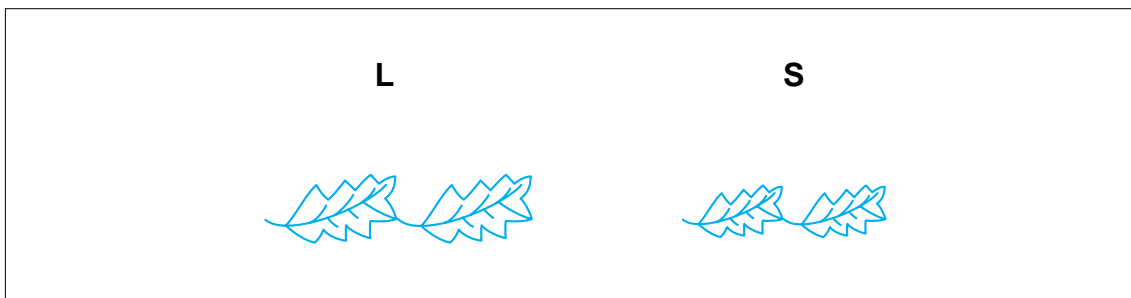
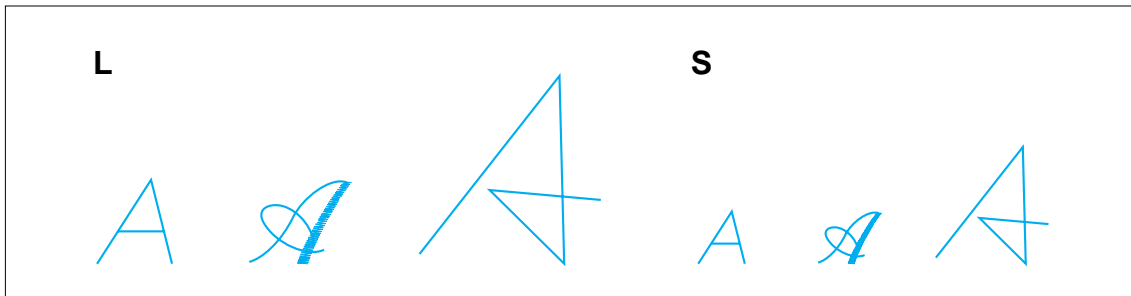

Single/repeat sewing

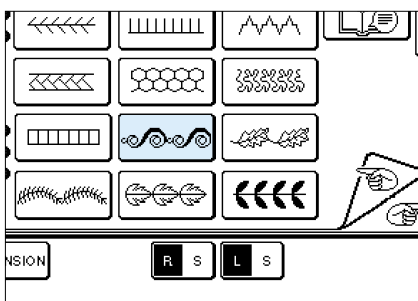

Touch the “**R S**” (repeat/single) key to sew one stitch pattern only or to repeat same stitch pattern.

1. Select the pattern.
2. Touch the “**R S**” (repeat/single) key. The selected stitch pattern will be single.

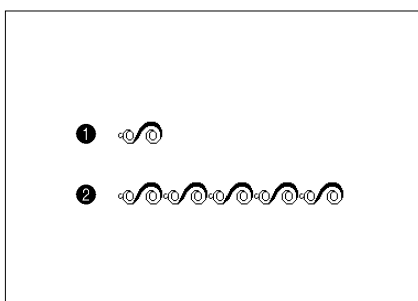

- 1 Single sewing
- 2 Repeat sewing

Note

If “repeat sewing” has been selected, you can switch to “single sewing” as you approach the end of the next decorative stitch.

Elongation

For satin stitches, it is possible to use the “” key to change the size of the pattern in five steps without changing the stitch width or stitch length.

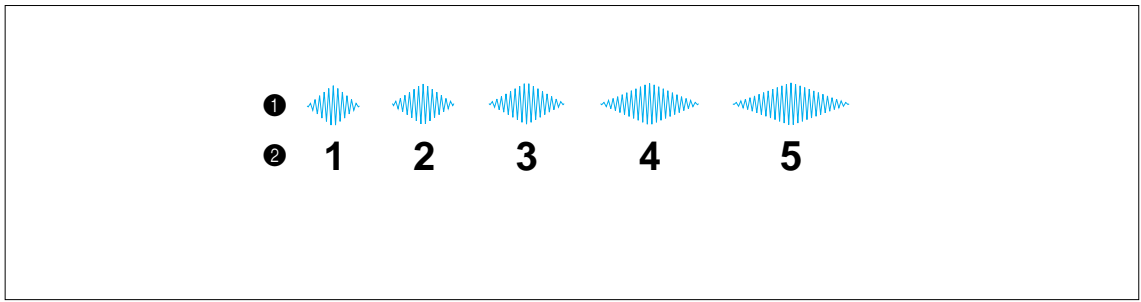

- ① Actual size
- ② Pattern length

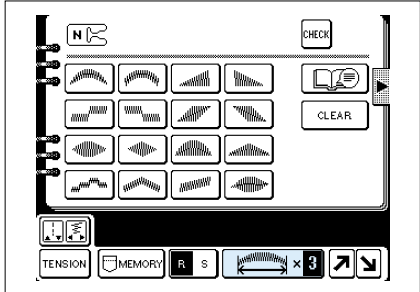

1. To change the length of the pattern, touch the “” key to change the number.

* The number shown in the darkened square indicates the current setting.

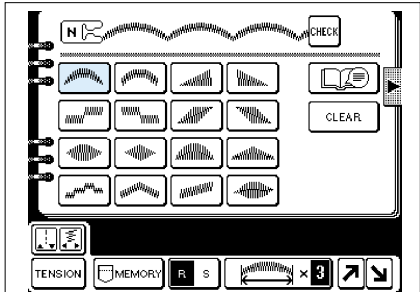

2. Select the pattern.

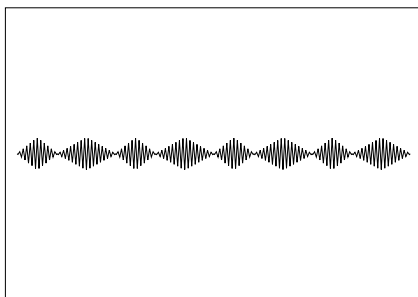

Example: To combine “ x 1” and “ x 3”

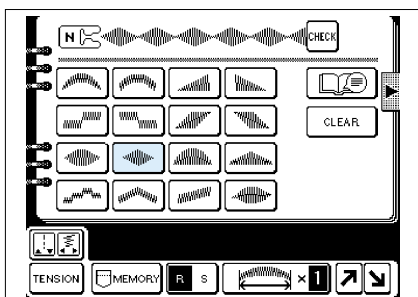

Note

Pressing the  key will provide a confirmation of the selected stitches.

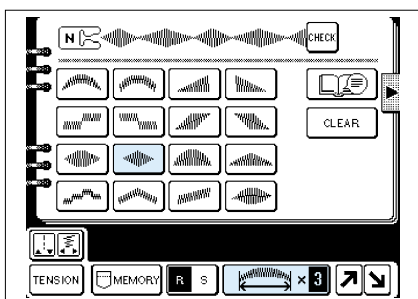

1. Select the “” stitch.



2. Touch the “ x 1” key twice to switch to “ x 3”.

3. Select the “” stitch.

The thread may easily become knotted when certain types of fabric or thread are used; therefore, the upper thread tension should be adjusted according to the application.

Changing the stitch length and the stitch width

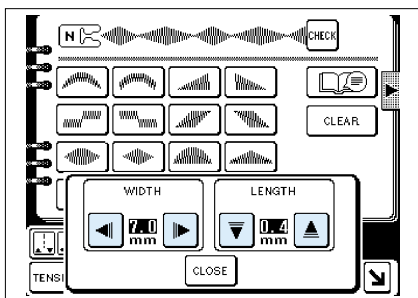

Touch the “” key.

The stitch width and stitch length setting screen will be displayed.

Touch the stitch width and stitch length setting keys to change the settings. (Refer to pages 24 to 26.)

The thread may easily become knotted when certain types of fabric or thread are used; therefore, the upper thread tension should be adjusted according to the application.

Customize patterns by combining satin stitches using the “↗” and “↘” keys



One touch of the “up” key will move the stitch pattern up half of it’s finished height.



One touch of the “down” key will move the stitch pattern down half of it’s finished height.

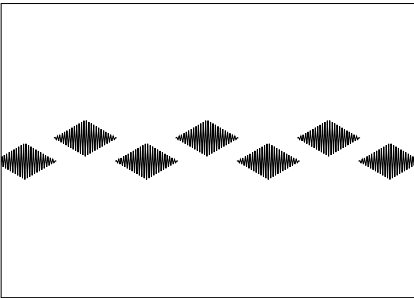

Example: Satin stitch pattern

Note

Pressing the key will provide a confirmation of the selected stitches.

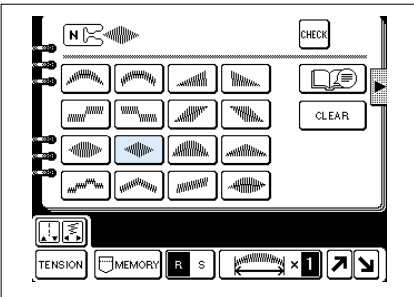

1. Select the pattern.

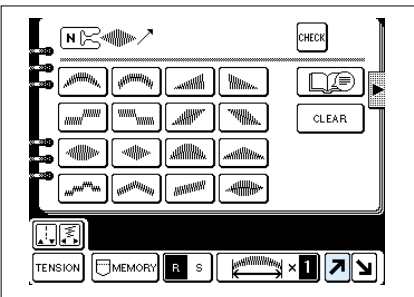

2. Touch the “↗” key. The next pattern will move up half of it’s finished height.

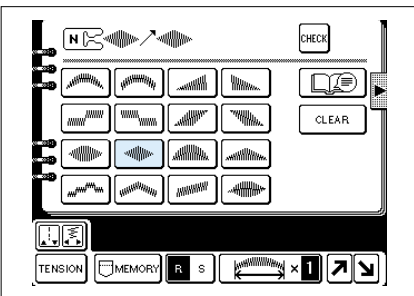

3. Select the pattern.

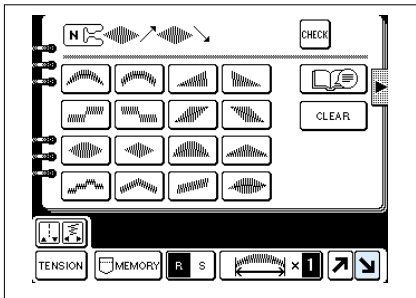

4. Touch the “↙” key. The next pattern will move down half of it's finished height.

Making various pattern combinations



| Stitch pattern | Operation |
|----------------|-----------|
| | |
| | |

Note

Pressing the key will provide a confirmation of the selected stitches.

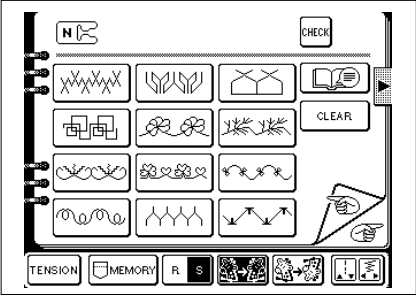
Changing Mirror Image [Left and Right (the “” key), and Top and Bottom (the “” key)]



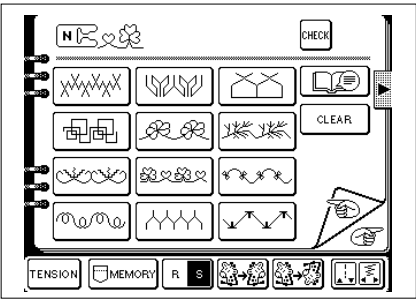

1. Touch the “” key.
Mirror Imaging with the “” Key

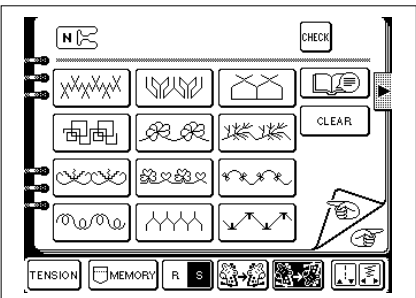
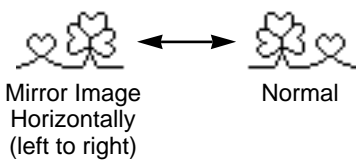

2. Patterns selected when this key is activated will be mirror imaged from left to right.



1. Touch the “” key.
Inverting with the “” Key

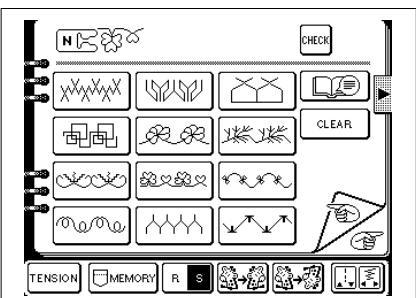

2. Patterns selected when this key is activated will be mirror imaged from top to bottom.

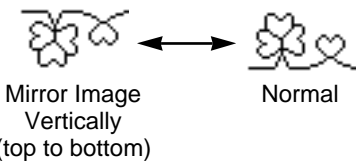

Confirming entry of combined stitch patterns CHECK

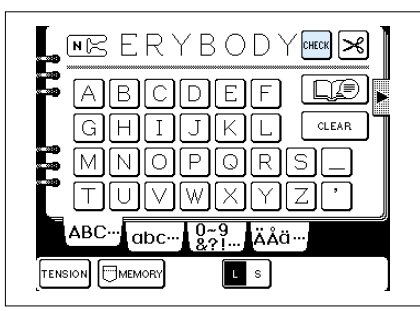

1. Touch the “CHECK” key. Stitch patterns will appear while moving on the screen.

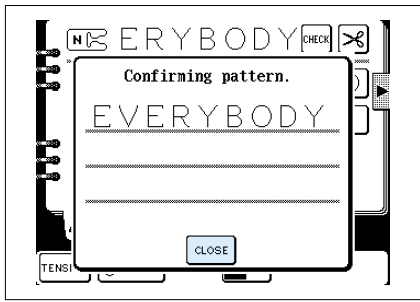

2. After checking the patterns, touch the “CLOSE” key. The display will return to the original screen.

Saving combined stitch patterns MEMORY

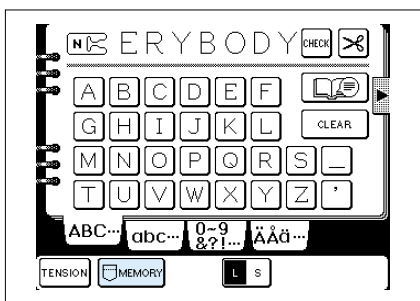

You can save words, your name for example, and patterns that you use often into the machine’s memory. The memory can save up to 12 such patterns.

After you have combined characters or patterns, touch the “MEMORY” key. Once the pattern has been saved, the display will return to the previous screen. Refer to page 156 for details on how to retrieve characters and patterns which have been saved in memory.

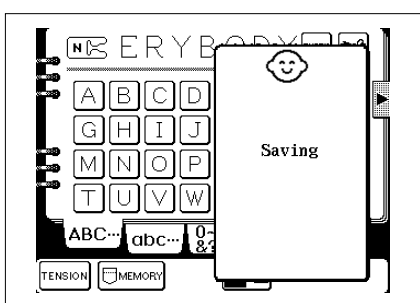

CAUTION
Do not turn off the power while the word “Saving” is displayed on the screen. If you turn off the power during this time, the data being stored may be deleted.

* It takes approximately 10 seconds for a pattern to be saved. For details on retrieving a pattern which has been saved, refer to page 156.

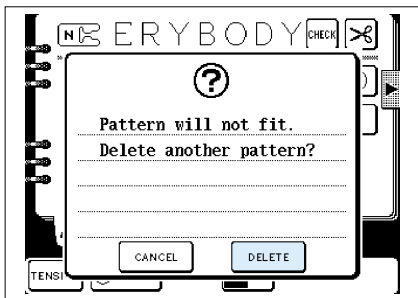

If the memory is full and no more patterns can be saved

To delete a pattern that is already saved in the memory, touch the “DELETE” key; to cancel the saving of a pattern, touch the “CANCEL” key.

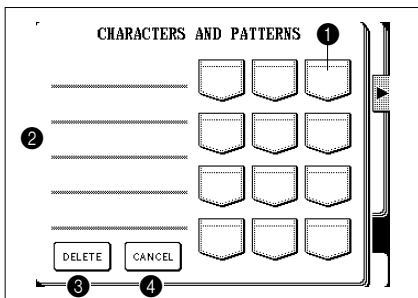

Erasing a pattern

1. Touch the “DELETE” key.

- ① This indicates a pocket which has a pattern saved in it.
- ② If you touch pockets, the pattern which is saved in that pocket will be displayed.
- ③ Touch this key to delete a saved pattern.
- ④ Touch this key to cancel the erasing of a saved pattern.

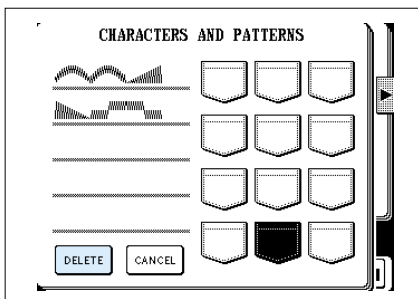

2. Touch a pocket key to select the pattern to delete, and then touch the “DELETE” key.

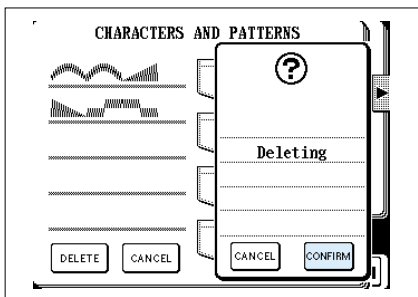

3. Touch the “CONFIRM” key.

The new pattern will then be saved automatically.

- * To cancel the deleting of a pattern, touch the “CANCEL” key.

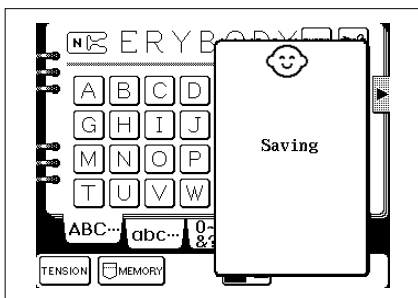

SEWING

Sewing attractive finishes

Refer to the table below and the “RELATED CHART OF SEWING FABRICS, THREADS AND NEEDLES” for recommended fabrics, threads and needles to use in order to obtain attractive sewing finishes. Furthermore, fabric pattern slippages may occur when using different fabric thicknesses or types of stabilizers. Be sure to carry out a test sewing beforehand to check.

| | |
|--------|--|
| FABRIC | When sewing thin or stretch fabrics, fabrics with coarse weaves, or characters/decorative stitches stored in the machine attach interfacing to the reverse side. If you do not wish to attach interfacing, place the fabric onto a thin paper such as tracing paper before starting to sew. This acts as a stabilizer. |
| THREAD | #50 – #60 |
| NEEDLE | Thin and medium fabrics 75/11 (Embroidery) |
| | Thick fabrics 90/14 (Embroidery) |
| | Stretch fabrics #14 (Golden needle) |

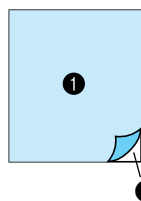

- ① Fabric
- ② Stabilizer
- ③ Thin paper

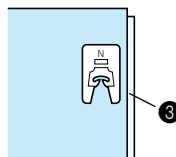

Using a pattern sheet

You can use the clear plastic pattern sheet which is provided as an accessory to make reference marks on your material for use in positioning. This is particularly helpful when sewing large characters.

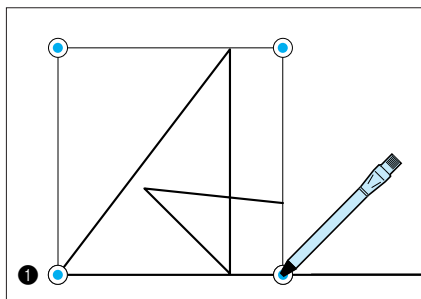

1. Align the picture on the pattern sheet with the place where the pattern is to be sewn on the fabric, and use a chalk pen to make marks on the fabric at the positions of the holes.

* When sewing patterns in mirror image, turn the pattern sheet upside-down.

- ① Initial needle drop point

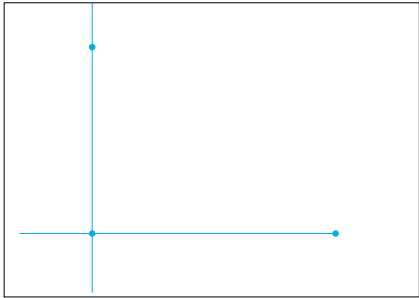

2. Draw lines to join the marks as shown in the illustration.

Sewing

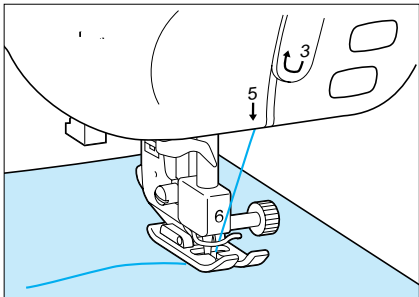

1. Attach presser foot "N".
2. Place the fabric under the presser foot, pull the upper thread out to the side and then lower the presser foot.

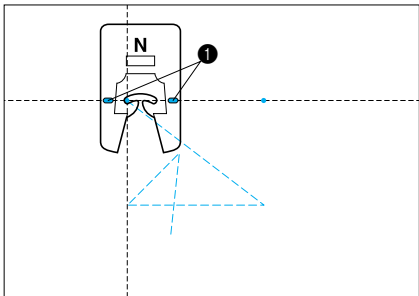

* If you used the pattern sheet to make positioning marks on the fabric, place the fabric so that the marks are aligned with the needle reference points in the presser foot and pull the upper thread out to the side before lowering the presser foot.

- ① Needle hole reference line

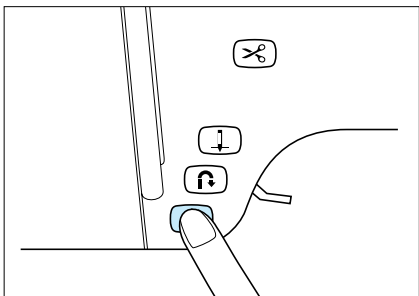

3. Press the "START/STOP" button. Sewing will then start.

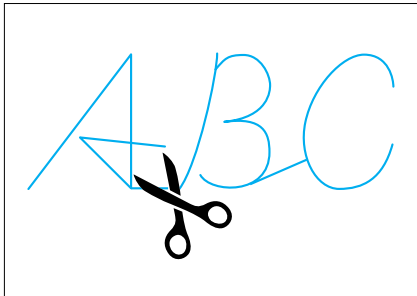
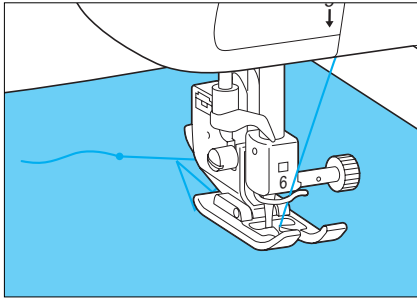

4. Once sewing of the character has been completed, the machine will automatically sew a reinforcement stitch and then stop.

- * When the automatic thread cutting is set, the machine trims both threads automatically after sewing is completed, and the machine will move on to the next sewing position before stopping.
- * When sewing continuous patterns, press the “START/STOP” button to stop the machine, and then press the “REVERSE STITCH” button to sew a reinforcement stitch.

5. When sewing is completed, trim any excess thread.

CAUTION

When sewing some patterns, the needle will stop in the raised position while the fabric is fed due to the needle bar separation mechanism which is used in this machine. At such times, a clicking sound which is different from the sound generated during sewing will be heard, but this sound is normal and is not the sign of a malfunction.

ADJUSTING STITCH PATTERNS



A stitch pattern may get deformed due to the weave of thread or cloth. It is a good idea to first make a trial stitching, and then make adjustments for each stitch pattern if necessary.

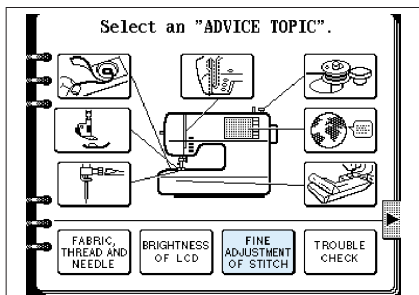

1. Touch the “OPERATION GUIDE” key.
2. Touch the “FINE ADJUSTMENT OF STITCH” key.

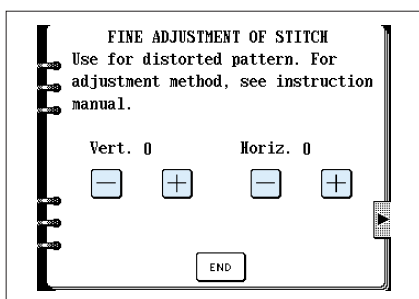

3. Attach presser foot “N” and then start embroidering. A trial pattern for adjustment purposes can then be embroidered. Adjust shape of stitch using the “+” and “-” keys.

* From -9 to +9

4. Touch the “END” key when the adjustment is finished.

| Stitch pattern | Remedy |
|----------------|---------------|
| | Correct shape |
| | Vert. “+” |
| | Vert. “-” |
| | Horiz. “+” |
| | Horiz. “-” |

4. EMBROIDERING

PREPARATION BEFORE SEWING



BE SURE TO ATTACH A PIECE OF STABILIZER FABRIC TO THE BACK OF THE MATERIAL BY IRONING BEFORE STARTING TO EMBROIDER

Using stabilizer fabric is an indispensable part of creating attractive embroidery. It is particularly important to attach stabilizer fabric to the back of stretch fabrics, thin fabrics and fabric with coarse weaves. If necessary, two thicknesses of stabilizer fabric can be attached. If embroidering on fabrics which cannot be ironed, or in places where ironing is difficult, place the stabilizer fabric underneath the frame before embroidering. Use stabilizer fabric which is larger in area than the frame, and make sure that the stabilizer fabric is clamped all the way around by the frame to prevent the fabric from becoming loose.

NOTES ON THE EMBROIDERY UNIT

- (1) Always turn off the main power switch when connecting or removing the embroidery unit and embroidery card (memory card).
- (2) Connect embroidery unit firmly into the plug connector and socket of the machine.
- (3) Do not touch the connector of embroidery unit.
- (4) You cannot use a foot controller when the embroidery unit is operational.
- (5) Always keep the embroidery unit and the memory card in designated cases.
- (6) Do not carry the machine while the embroidery unit is connected.
- (7) Always set your machine on a level surface.

* The sewing speed is controlled by the machine automatically according to the pattern selected.

Attaching embroidery foot “Q”

CAUTION

Be sure to turn off the power before attaching the embroidery foot “Q”. If the power is left on and the “START/STOP” button is accidentally pressed, the machine will start operating, which could result in serious injury.

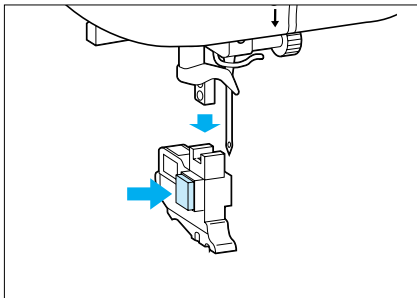

1. Press the “NEEDLE POSITION” button to raise the needle, and then turn off the power.
2. While pressing the button to the left of the presser foot holder, pull the presser foot holder downward to remove it.

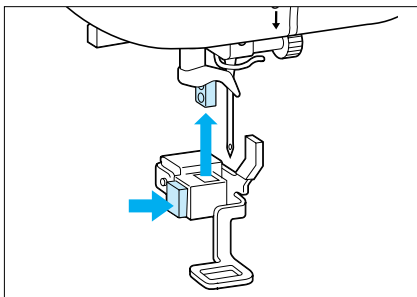

3. Raise the presser foot lever to the highest position. While pressing the button to the left of the embroidery foot “Q”, push embroidery foot “Q” firmly upward with both hands to install it.

CAUTION

Be careful not to touch the needle during this time, otherwise injury may result.

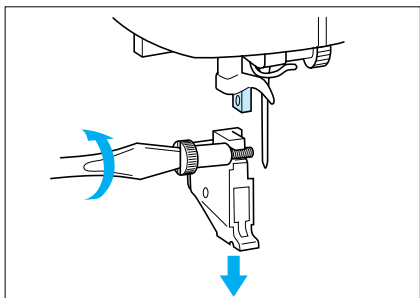

1. Press the “NEEDLE POSITION” button to raise the needle, and then turn off the power.
2. Raise the presser foot lever.
3. Loosen the set screw to remove the presser foot holder.

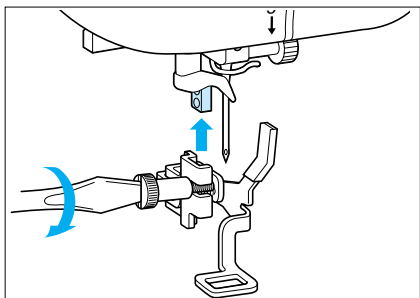

4. Attach the embroidery foot “Q”.
5. Set arm of embroidery foot “Q” on needle holder, use the metal disk provided with your machine (accessory #14 on page 7) or a screwdriver to tighten the screw firmly.

CAUTION
Be careful not to touch the needle during this time, otherwise injury may result.

- NOTE**
- Make sure that there is no gap between the needle bar and embroidery foot “Q”.
 - It is recommended that a 90/14 needle should be used when embroidering on thicker fabrics or stabilizing products. (for example denim, puffy foam . . .) A 75/11 needle might be bent or broken, which could result in injury.

Fitting embroidery unit

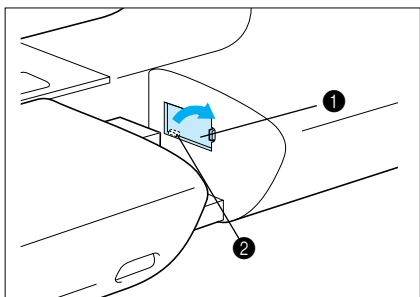

Always turn off the power supply before carrying out the procedure below.

1. Turn off the power.
2. Open the cover of the connecting slot by rotating the plastic bracket in the direction indicated by the arrow.

- ① Connecting slot
- ② Plastic bracket

* When the embroidery unit is not being used, close the cover of the connecting slot.

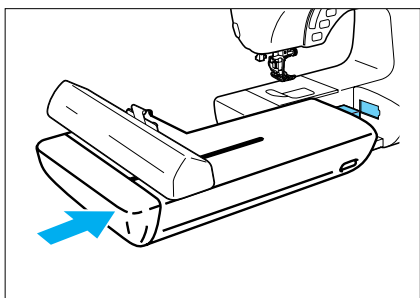

3. Insert the connector of the embroidery unit into the slot and check that it is connected properly.

* Put the machine on a flat and horizontal surface and slide the embroidery unit towards the machine.

Removing the embroidery unit

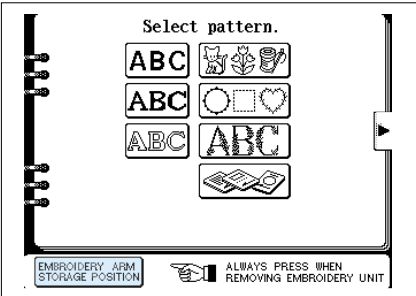

1. Make sure that the embroidery frame has been removed, touch the “EMBROIDERY” key or the “EMBROIDERY EDIT” key, and then touch the “EMBROIDERY ARM STORAGE POSITION” key. The carriage will move to the removal position.

CAUTION
If the above procedure is not carried out, the embroidery unit cannot be placed in the case.

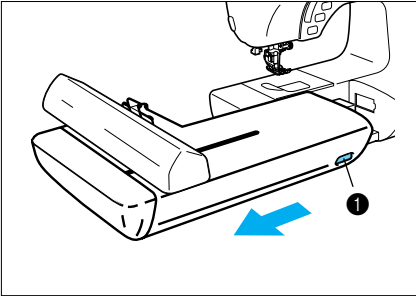

2. Turn off the power, hold the left side of the embroidery unit, and while pressing the release button, gently slide the embroidery unit away from the machine.

① Release button

CAUTION
Make sure that the power is turned off, otherwise damage may result.

Placing the embroidery unit into its case

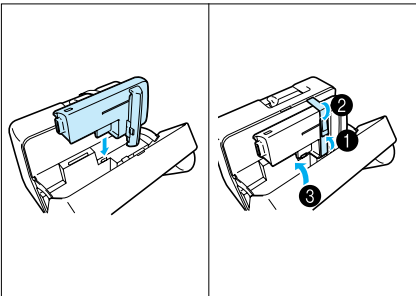

- ① Hook the embroidery unit onto the tab inside the case.
- ② Secure the embroidery unit with the band.
- ③ Close the cover.

Initializing the embroidery unit

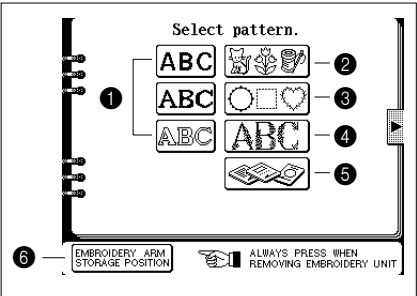
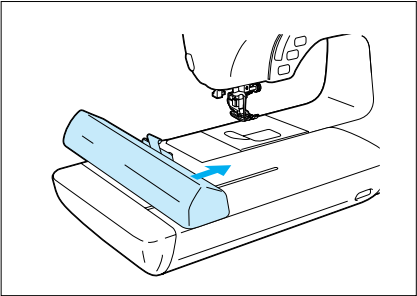
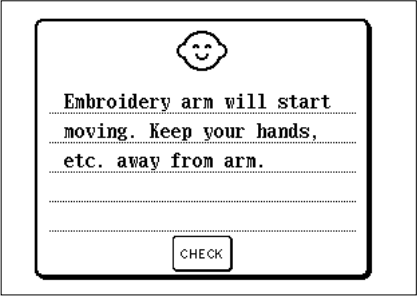

1. Turn on the power. The following display will appear on the LCD.

* When the buttonhole lever, the needle or the presser foot lever are lowered or when the bobbin winding shaft is at the right, an error message will vary depending on which of the conditions mentioned above is occurring. The display shown at left will appear after the error condition has been remedied.

2. Touch the "CHECK" key.
The carriage will move in order to initialize the embroidery unit.

CAUTION
Do not place your hands near the embroidery arm, otherwise injury may result. Please note that the embroidery arm may make an unusual noise while initialization is being carried out, but this is normal. If the initialization could not be carried out normally, a buzzer will sound. If this occurs, make sure that the embroidery frame is not attached and try again to initialize the embroidery unit. This is not a malfunction.

The types of patterns available will then be displayed on the LCD.

- ① Alphabetical characters
- ② One-point patterns
- ③ Frame patterns
- ④ Floral alphabets
- ⑤ Patterns found on memory card (optional)
- ⑥ Touch to position the embroidery arm for removing unit.

SELECTING AND SEWING PATTERNS

Selecting alphabetical characters

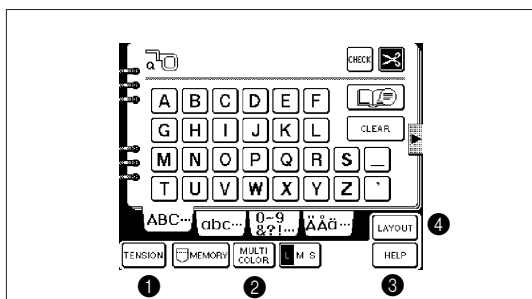
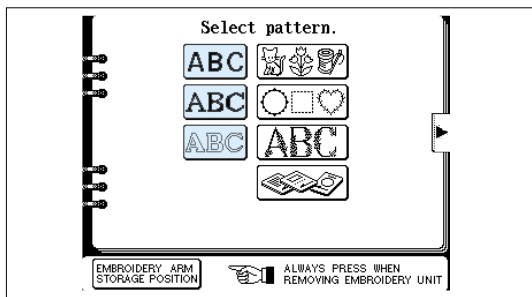

How to combine characters

1. Select the character required.

ABC ABC ABC

- * If another screen is being displayed, touch the "EMBROIDERY" key before selecting the character.

2. Combine characters. (Refer to page 89.)

- 1 Touch this key to change the thread tension and the stitch density. (Refer to page 29 and page 122.)
- 2 Touch this key when you want to change the color of each character sewn. When displayed in reverse, the machine will sew a reinforcement stitch and stop after each character is embroidered.
- 3 Touch this key if the thread breaks during sewing or if you would like to sew again from the beginning. (Refer to page 129.)
- 4 Touch this key to move the sewing position. (Refer to page 123.)

Selecting one-point patterns

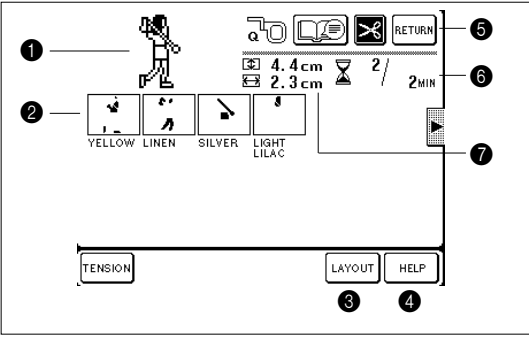
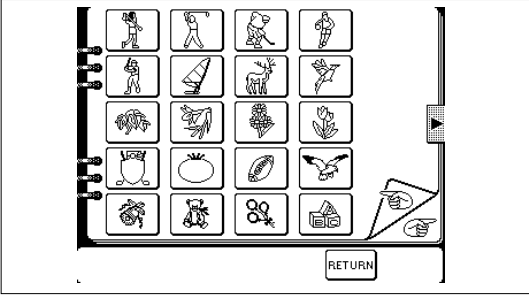
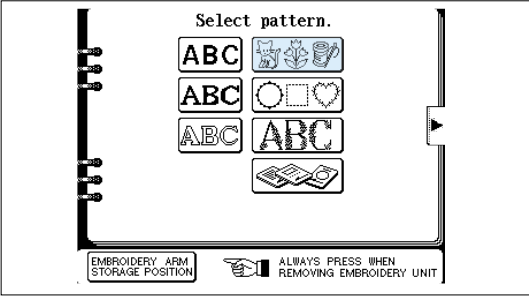

1. Touch the “ ” key.
The one-point pattern selection screen will be displayed.

* If another screen is being displayed, touch the “EMBROIDERY” key before touching the one-point pattern key.

2. Select the desired pattern.
The sewing screen will be displayed.

* If you touch the “ ” key, the next sewing screen will be displayed.

If you touch the “ ” key, the previous sewing screen will be displayed.

* If you touch the “RETURN” key, the pattern selection screen will be displayed.

- ① The selected pattern will be displayed.
- ② This indicates the order of color changes. The color displayed below each pattern is for reference only. For details about the color change table, refer to page 191.
- ③ Touch this key to move the sewing position. (Refer to page 123.)
- ④ Touch this key if the thread breaks during sewing or if you would like to sew again from the beginning. (Refer to page 129.)
- ⑤ Touch this key to return to the previous screen (pattern selection screen).
- ⑥ This shows the amount of time required to embroider the pattern and the total amount of time remaining. It does not include the time needed to change colors. (The totals are calculated and displayed after a pattern is selected.)
- ⑦ This shows the size of the pattern.

Selecting frame patterns

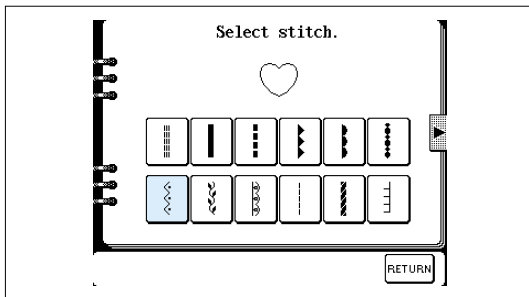
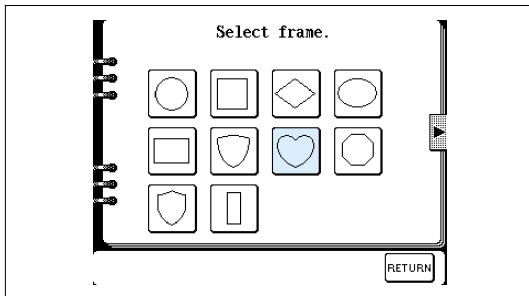
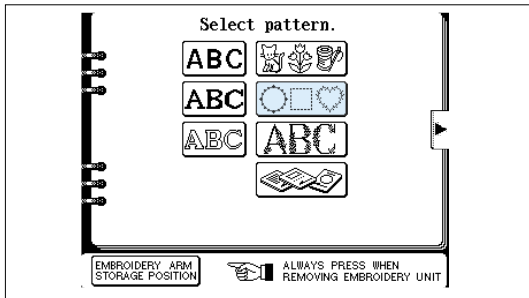

Frame patterns are created by combining the desired frame and type of stitch.

1. Touch the “” key. The frame pattern selection screen will be displayed.
 - * If another type of pattern such as characters was selected previously or if a memory card has been inserted, touch the “EMBROIDERY” key first and then touch the frame pattern key.
2. Select the desired shape for the frame. The frame pattern will be selected and the stitch pattern selection screen will be displayed.
 - * If you touch the “RETURN” key, the previous screen will be displayed.
3. Select the desired type of stitch to form the frame. The combined pattern is then shown on the LCD screen.

The selected pattern can be changed with the options shown on screen.

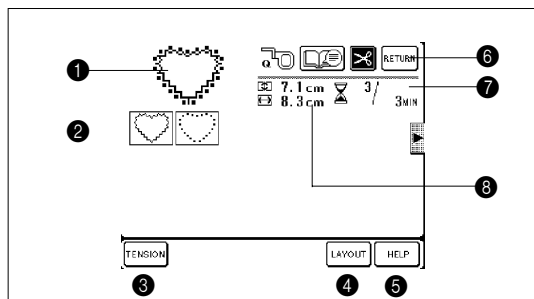

- ❶ Indicates the stitch selected for the frame pattern.
- ❷ This indicates the order of color changes.
- ❸ Touch this key to change the thread tension and the stitch density. (Refer to page 29 and page 122.)
- ❹ Touch this key to move the sewing position. (Refer to page 123.)
- ❺ Touch this key if the thread breaks during sewing or if you would like to sew again from the beginning. (Refer to page 129.)
- ❻ Touch this key to return to the previous screen (pattern selection screen).
- ❼ This shows the amount of time required to embroider the pattern and the total amount of time remaining. It does not include the time needed to change colors. (The totals are calculated and displayed after a pattern is selected.)
- ❽ Indicates the current pattern size.

Selecting floral alphabets

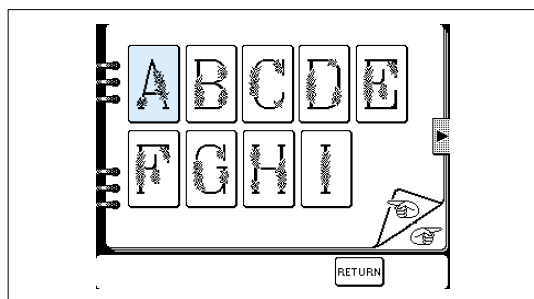
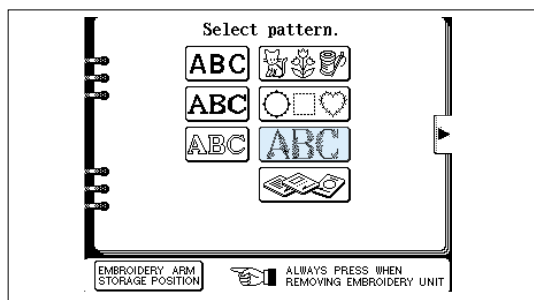

1. Touch the "ABC" key.
- * If another screen is being displayed, touch the "EMBROIDERY" key before touching the "ABC" key.
2. Select the pattern you require.
3. The sewing screen will be displayed.
- * These patterns can also be used to embroider alphabet characters without embroidering the flowers.

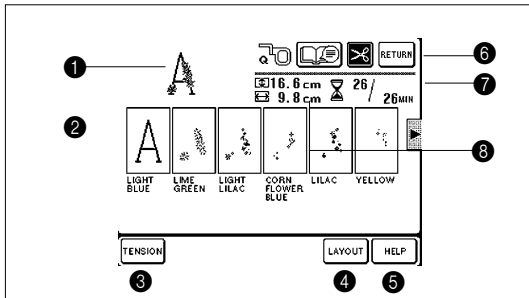

- ① Indicates the pattern selected.
- ② This indicates the order of color changes. The color displayed below each pattern is for reference. For details about the color change table, refer to page 191.

* If you would like to embroider just the alphabetical characters, embroider the color of the alphabet characters only.

- ③ Touch this key to change the thread tension.
- ④ Touch this key to move the sewing position. (Refer to page 123.)
- ⑤ Touch this key if the thread breaks during sewing or if you would like to sew again from the beginning. (Refer to page 129.)
- ⑥ Touch this key to return to the previous screen (pattern selection screen).
- ⑦ This shows the amount of time required to embroider the pattern and the total amount of time remaining. It does not include the time needed to change colors. (The totals are calculated and displayed after a pattern is selected.)
- ⑧ This shows the size of the pattern.

Selecting patterns from a memory card

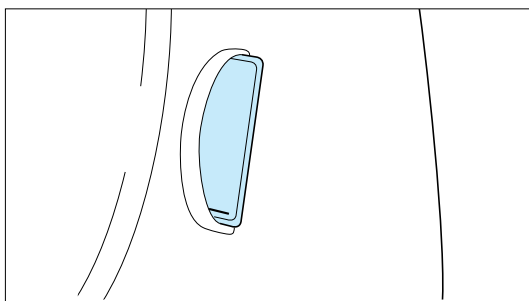
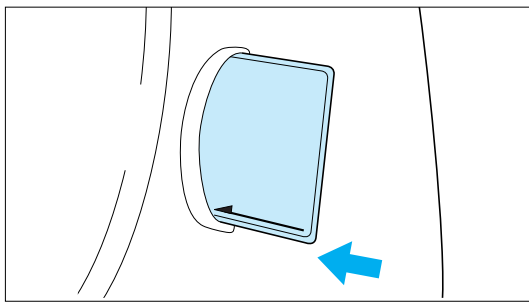

1. Hold the memory card so that the arrow is facing toward you, and then insert it all the way into the slot on the right side of the machine.

CAUTION

- Be sure to insert and remove the memory card only while “” is being displayed or while the power is turned off.
- Do not insert the card in any direction other than that described above, and do not force it into the slot, otherwise the card or the slot may become damaged.
- Insert so that the card appears as shown in the illustration at left. If you try to push the card in any further, the connector will become damaged.

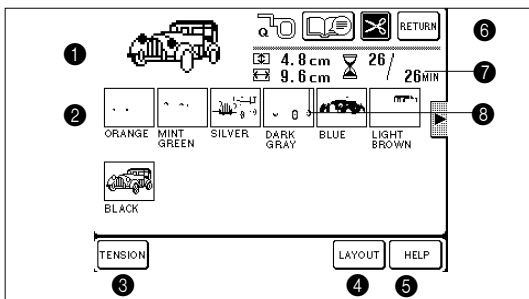
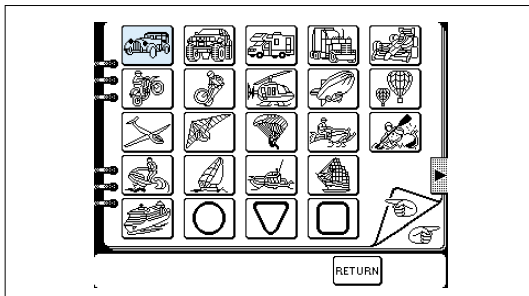
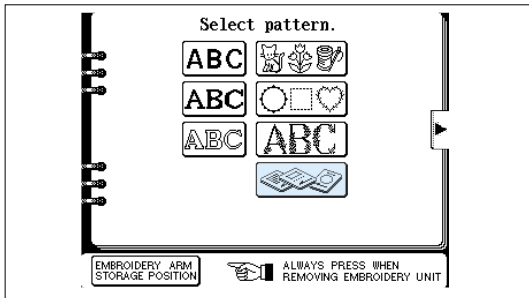

2. Touch the “” key.

3. The memory card pattern selection screen will be displayed. [The illustration at left shows the Transportation card No.12 (SA312, XA0275-001) (option).]

* If another screen is being displayed, touch the “EMBROIDERY” key before touching the “” key.

4. Select the desired pattern.

* If you touch the “RETURN” key, the previous screen will be displayed.

- ① Indicates the selected pattern.
- ② This indicates the order of color changes. The color displayed below each pattern is for reference.
- ③ Touch this key to change the thread tension.
- ④ Touch this key if you would like to move the sewing position. (Refer to page 123.)
- ⑤ Touch this key if the thread breaks during sewing or if you would like to sew again from the beginning. (Refer to page 129.)
- ⑥ Touch this key to return to the previous screen (pattern selection screen).
- ⑦ This shows the amount of time required to embroider the pattern and the total amount of time remaining. It does not include the time needed to change colors. (The totals are calculated and displayed after a pattern is selected.)
- ⑧ This shows the size of the pattern.

MEMORY

Saving a pattern combination in memory

Memorizing combined pattern in memory for later use (12 memories are available)

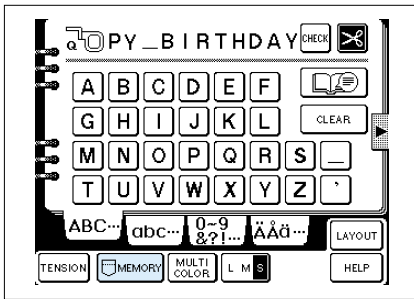

You can combine and save characters and all edited embroidery patterns.

Example: To save the “HAPPY BIRTHDAY” pattern in memory address 1.

1. Enter the characters to create the pattern.

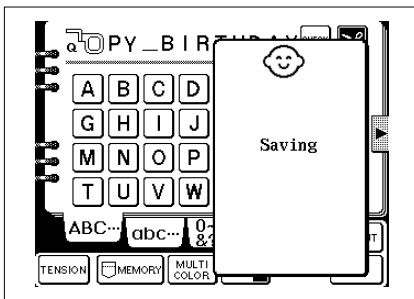

2. Touch the “MEMORY” key. Once the pattern has been saved, the display will return to the previous screen.

- * Do not turn off the power while a pattern is being saved (while “Saving” is displayed).
- * It takes approximately 10 seconds for a pattern to be saved. For details on retrieving a pattern which has been saved, refer to page 156.



If the pattern cannot be saved Refer to page 100.

EMBROIDERING

Embroidering attractive finishes

Refer to the table below and the “RELATED CHART OF SEWING FABRICS, THREADS AND NEEDLES” to use in order to obtain attractive sewing and embroidery finishes. Pattern slippages may occur when using different fabric thicknesses or types of stabilizers. Be sure to carry out a test sewing beforehand to check.

| | |
|--------|---|
| FABRIC | When embroidering fabrics, attach a non-woven type of stabilizer fabric. * It is recommended that you use a special stabilizer fabric for embroidering which can be torn off around the design when the project is finished. |
| THREAD | Upper thread Brother poly 40 color thread set (#50) Refer to page 8. Bobbin thread Brother embroidery bobbin thread Refer to page 8. |
| NEEDLE | 75/11 (Embroidery) |

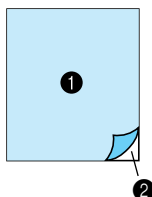

- ① Fabric
- ② Stabilizer

Always use Brother embroidery bobbin thread.
Adjust thread tension when thread quality is not compatible.

Setting the fabric into the embroidery frame

Three types of embroidery frames are available: Large, medium and small
Embroidering area for large frame: 18 cm (H) × 13 cm (W)
Embroidering area for medium frame: 10 cm (H) × 10 cm (W)
Embroidering area for small frame: 2 cm (H) × 6 cm (W) (for embroidering initials)

CAUTION

Depending on the size of the pattern and the position of the pattern to be embroidered, it may not be possible to use the medium and small frames. When using these frames, be sure to check the layout screen display (refer to page 123) before starting to embroider any patterns. If the frames are used by mistake, the presser foot may strike the frames, which could cause injury.

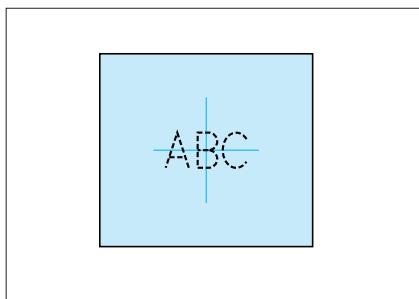

1. Mark the fabric using a chalk pen or fabric marking pen to indicate the embroidering position.

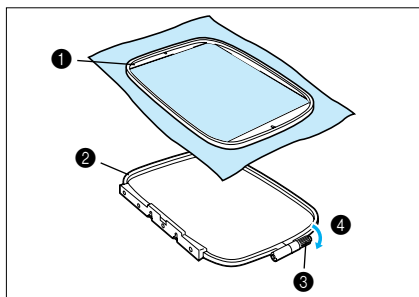

2. Loosen the adjusting screw and separate the inner and outer frames. Lay the fabric on top of the outer frame and secure it between the inner and outer frame, and tighten the adjusting screw just enough to secure the fabric. Gently remove the fabric from the frame without loosening the adjusting screw.

- ① Inner frame
- ② Outer frame
- ③ Adjusting screw
- ④ Loosen

- * This precautionary step will help reduce pattern distortion while embroidering.
- * Be sure to align the ▲ mark on the inner frame with the ▼ mark on the outer frame.

- ① Tighten

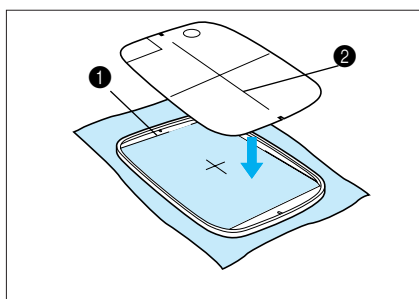
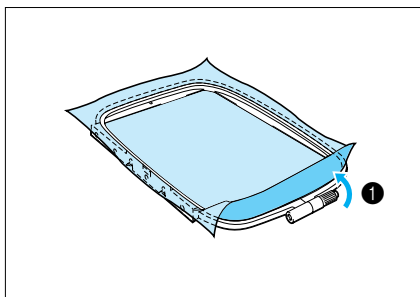

3. Place the embroidery sheet into the inner frame, while matching lines on the sheet with mark on fabric.

- * For best results lay the outer frame on a flat table surface and lay the fabric on top of it.

- ① Inner frame
- ② Standard line

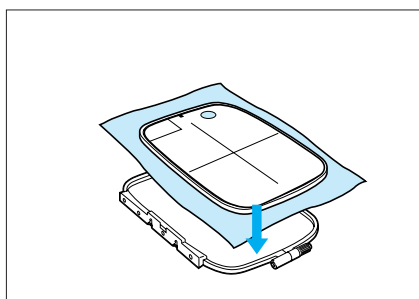

4. Press down into the outer frame so that the mark doesn't move out of place.

- ① Outer frame
- ② Inner frame
- ③ Surface of fabric



- * Press down firmly until the outer frame and inner frame are at the same height.

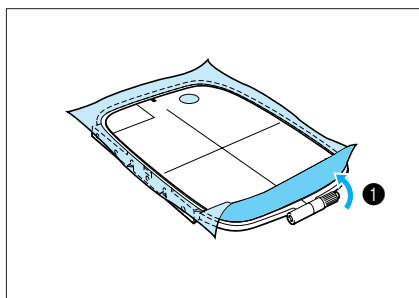

5. After the fabric is clamped between the inner and outer frame tighten the adjusting screw by hand.

- ① Tighten

- * To avoid stripping the screw, do not use a screwdriver to tighten.

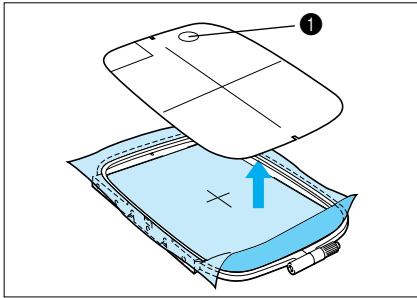

6. Remove the embroidery sheet before starting to embroider.

① Hole for removing

Fitting the embroidery frame to the embroidery unit

Be sure to wait until the embroidery unit has finished initializing before fitting the embroidery frame. (Refer to page 109.)

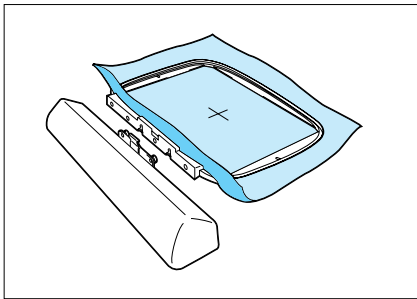

1. Raise the presser foot to its highest position. Then pass the embroidery frame under the presser foot with the mounting bracket on the left side and the fabric right side up.

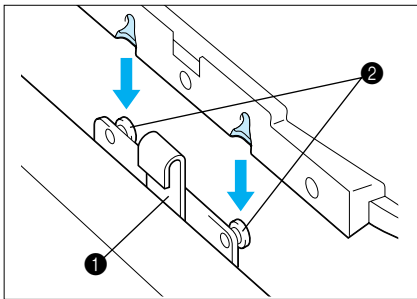

2. Align the two pins on the embroidery unit frame holder with the mounting bracket on the frame, and then press the frame into the embroidery unit frame holder until a click is heard.

① Embroidery arm frame holder

② Pins

* Be sure to insert both pins. If only the forward or the back pin is inserted, the pattern may not turn out correctly.

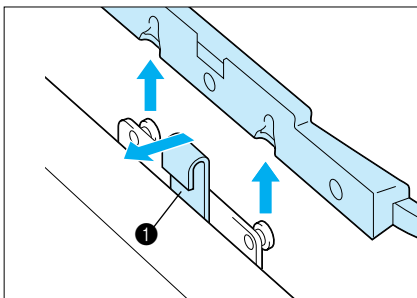

Removing the embroidery frame

While pushing the lever of the embroidery frame holder to the left, lift the embroidery frame up to remove it.

① Lever

Embroidering

Always use Brother embroidery thread.
Select from different thread qualities to achieve a variety of results.

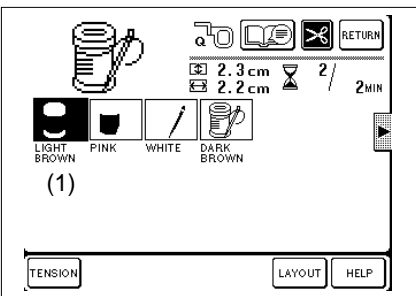
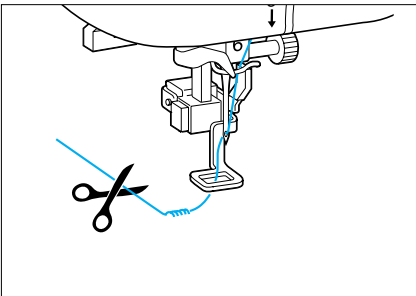
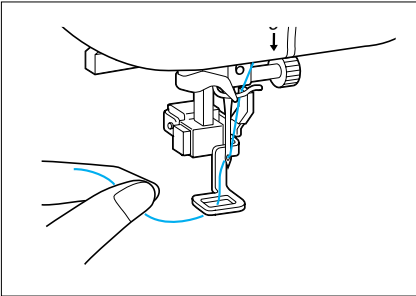
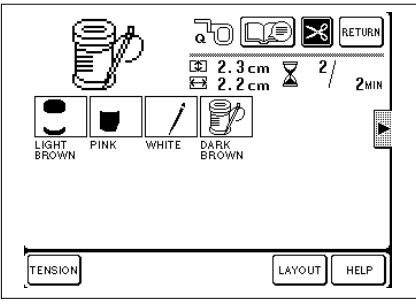

Example: 

1. Select the desired pattern.
The order of sewing for each part will be displayed.
 - * The color displayed below each pattern is for reference. Some color regions may not have a color displayed below them; you can sew these parts with any color you like.

2. Thread the needle for the first color and pass it through embroidery foot "Q". Hold this thread in your left hand while leaving a certain amount of slack in the thread.
 - * Be sure to raise the presser foot lever before threading the needle.

3. Lower presser foot lever and start embroidering. After 5 to 6 stitches have been sewn, stop the machine and cut off any surplus thread from the end of the seam.
 - * If you are using the embroidery unit, the foot controller cannot be used at this time.
 - * Sewing can start even if "  " is being displayed.

4. Start the machine once more.
The part indicated by (1) in the illustration will be embroidered and the machine will then stop automatically. Once embroidering is completed, the display will automatically move to the left and the next color to be embroidered will be displayed at the left edge of the screen.

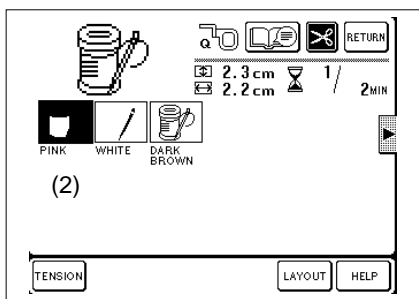

- Replace the upper thread with the thread for the second region of color, and then start the machine again. After the part indicated by (2) has been embroidered, the machine will once more stop automatically.

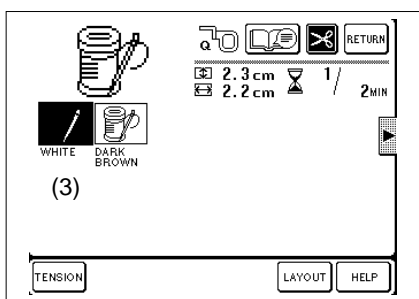

- Replace the upper thread with the thread for the third region of color, and then start the machine again. After the part indicated by (3) has been embroidered, the machine will once more stop automatically.

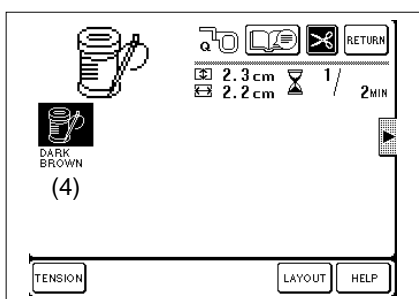

- Replace the upper thread with the thread for the fourth region of color, and then start the machine again. After the part indicated by (4) has been embroidered, the machine will once more stop automatically. The display will return to the original condition.
- Trim any excess thread.

Embroidering order for pattern parts

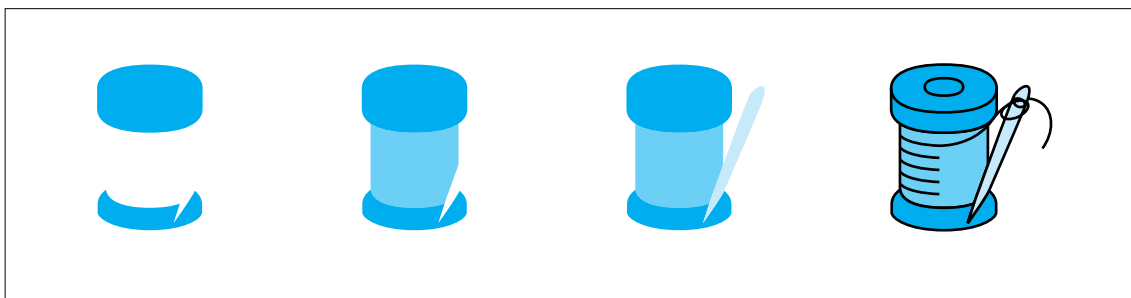

Embroidering a single color pattern when “MULTI COLOR” is displayed

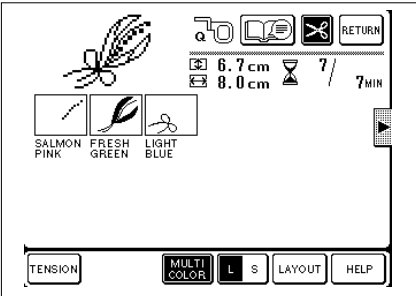

1. Touch the “MULTI COLOR” key to change to the single color mode. If the “START/STOP” button is pressed, a single color of the pattern will be embroidered and then the machine will stop automatically.
 2. Trim any excess thread.
- * This pattern is the No. 2 FLOWER pattern from the option card.

Changing the stitch density for characters and some frame patterns

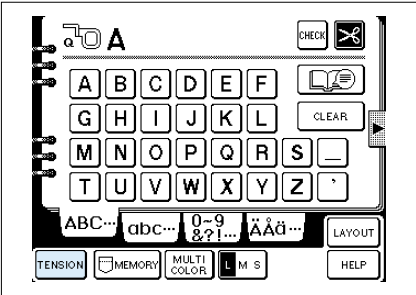

The stitch density adjustment is not available for all patterns. Patterns other than the characters and some frame patterns are not adjustable.

1. Touch the “TENSION” key.

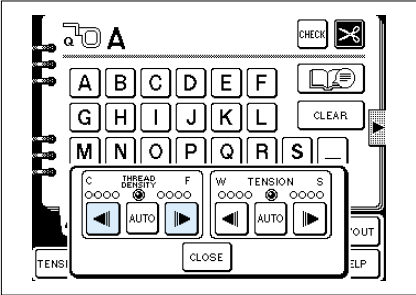

2. The stitch density will become further apart (coarser) each time the “◀” key is touched. The stitch density will become closer together (finer) each time the “▶” key is touched.

- ① AUTO
- ② Fine (stitches closer together)
- ③ Coarse (stitches farther apart)

* The normal setting is standard.

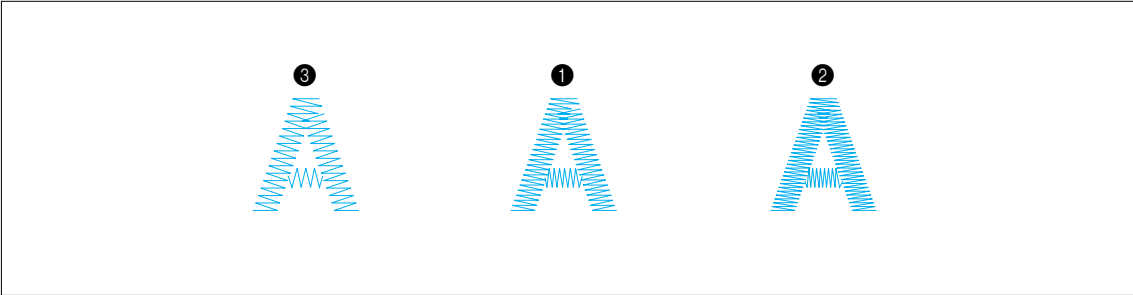

MOVING THE LOCATION (LAYOUT)

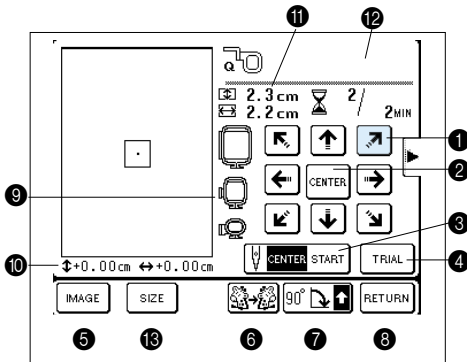
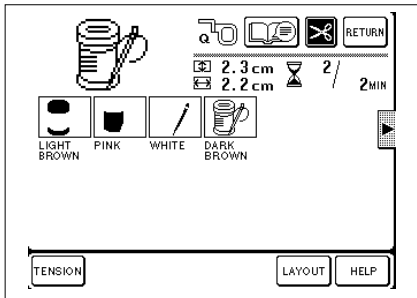

The position for embroidering the pattern can be changed by touching the “LAYOUT” key. This is useful if you want to embroider a pattern at a location such as in the corner of the fabric or if you want to align a pattern away from the center of the embroidery area of the frame.

Touch the “LAYOUT” key. The layout screen will be displayed.

- ① Touch these keys to move the embroidering position within the embroidery area.
- ② If you touch this key, the embroidering position will be returned to the center of the embroidery area.
- ③ This moves the needle position to the middle of the pattern or to the sewing start position, etc. Use it when you would like to set the embroidering position.
- ④ If you touch this key, the embroidery frame will move so that you can check the embroidering position.
- ⑤ If you touch this key, the pattern image will be displayed.
- ⑥ If you touch this key, the pattern will be reversed horizontally. This function cannot be used with some patterns.
- ⑦ Touch this key to rotate the selected pattern in 90° steps.
- ⑧ If you touch this key, the display will change from the layout screen back to the original screen.
- ⑨ This displays the different types of embroidery frames that can be used. (The frames that can be used will be shown in solid color, and the frames that cannot be used will be grayed out.)

CAUTION

Do not use any embroidery frames other than those shown here, otherwise injury could result.

- ⑩ This shows the distance from the center when the embroidering position has been moved.
- ⑪ Indicates the current pattern size.
- ⑫ If a character has been selected, this shows details about the character.
- ⑬ If you touch this key changing the size of pattern. (Refer to page 129)

Moving the embroidery location ↖ ↗ ↘ ↙ ⬆ ⬇ ⬇ ⬆

CAUTION
After a pattern has been moved, check the display to see which embroidery frames can be used. If an embroidery frame which is not displayed is used, the embroidery foot may touch the frame, or personal injury may result.

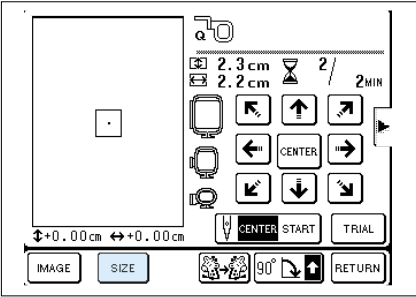

1. Touch the arrow key that indicates the direction in which you would like to move the pattern. The embroidery pattern will then move.
 - ① Shows the distance from the center position
 - * If you touch the “CENTER” key, the embroidering position will return to the center.
 - * Use the hole on the embroidery foot as a guide, and never lower the needle while it is moving.

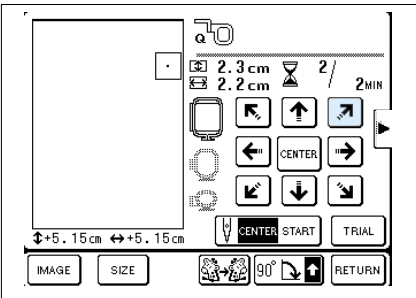

Example: To move the embroidering position to the upper right
Touch the “↗” key.

Checking the embroidering area TRIAL

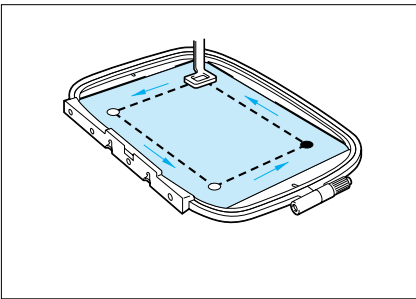

If the “TRIAL” key is touched, the embroidery frame will move and the presser foot will trace the embroidering area to be used for the currently selected pattern and size.

- * Do not lower the needle. Use the hole of the presser foot as a guide instead.

Embroidering from a specific starting point

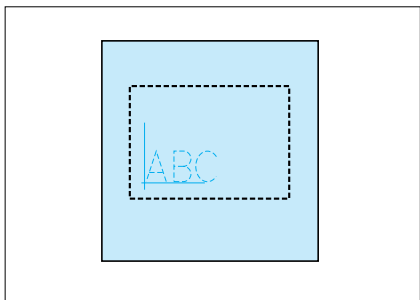

CAUTION

After a starting position has been rotated, check the display to see which embroidery frames can be used. If an embroidery frame which is not displayed is used, the embroidery foot may touch the frame, or personal injury may result.

1. Make a mark at the starting position on the fabric in the frame as shown in the illustration. The mark cannot be too close to the edge of the frame as the presser foot prevents the needle from getting very close to the frame.
2. Touch the "" key. The needle will move to the starting position. (The embroidery frame will move.)

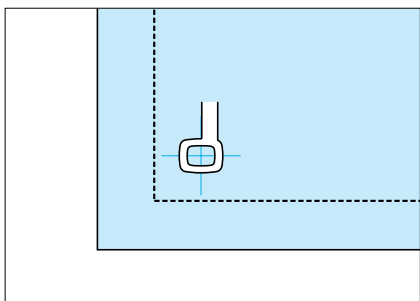
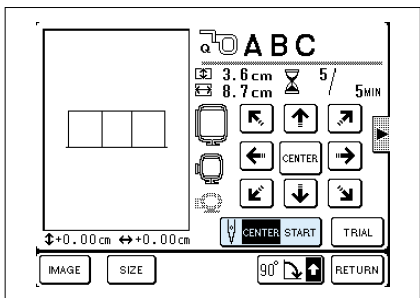

3. Use the arrow keys to align the mark with the hole in the embroidery foot, and then start embroidering.

Changing the pattern direction

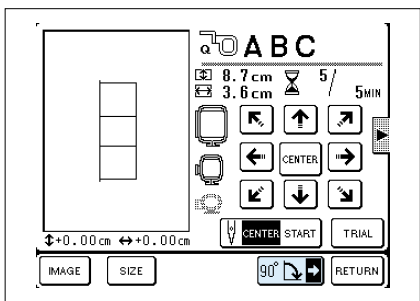

The pattern will be rotated clockwise in 90° steps as shown in the illustration at left each time the "" key is touched.

* Some patterns may be too long to be rotated 90°. In such cases, the patterns can be rotated by 180° only.

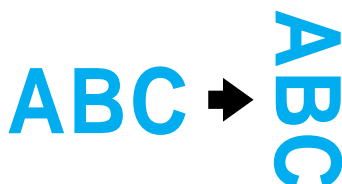

CAUTION

After a pattern has been rotated, check the display to see which embroidery frames can be used. If an embroidery frame which is not displayed is used, the embroidery foot may touch the frame, or personal injury may result.

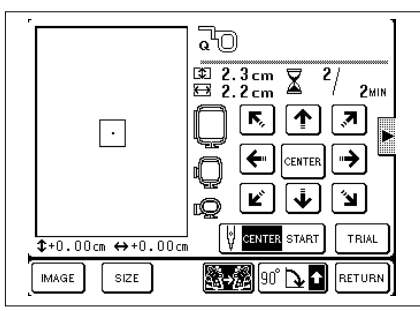

Reversing patterns



1. Touch the "
- * If the "
 - * The "

Using the "IMAGE" key

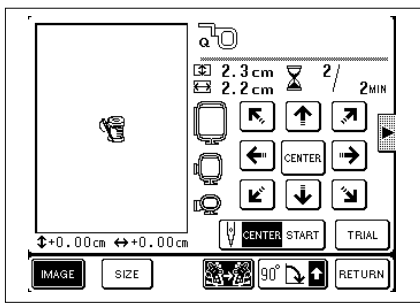

1. If you touch the "IMAGE" key, a scale showing the size of the pattern will be displayed.
- * If you touch this key once more, the display will return to the original screen.

Changing the size of characters, frame patterns and pattern SIZE

You can change the size of character and frame patterns to any size you wish.

[When changing character size]

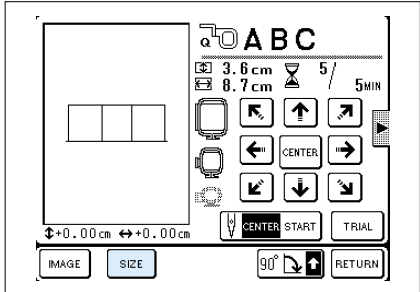

1. Touch the “SIZE” key.

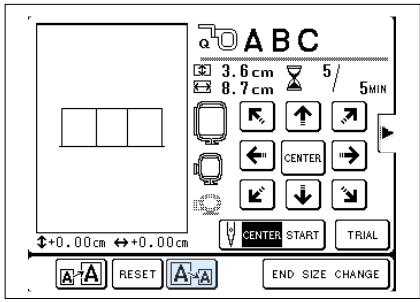

2. To increase the pattern size, touch the “**A+A**” key; to reduce the size, touch the “**A-A**” key to reset the size touch the “**RESET**” key. The size will change each time one of these keys is pressed.

- * The maximum frame pattern size is different for each pattern.
- * Some frame patterns can be enlarged further if they are rotated 90°.

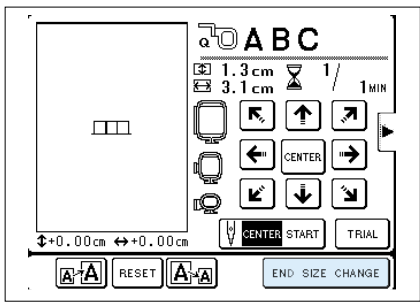

3. After adjustment is completed, touch the “END SIZE CHANGE” key.

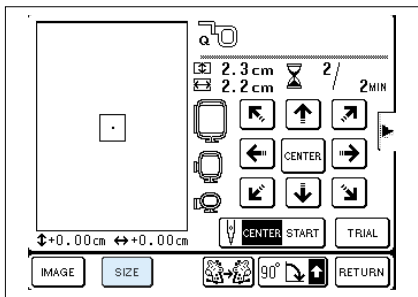

CAUTION
After the size of a character, frame patterns or embroidery patterns have been changed, check the display to see which embroidery frames can be used. If an embroidery frame which is not displayed is used, the embroidery foot may touch the frame, or injury may result.

[When changing frame pattern and patterns size]

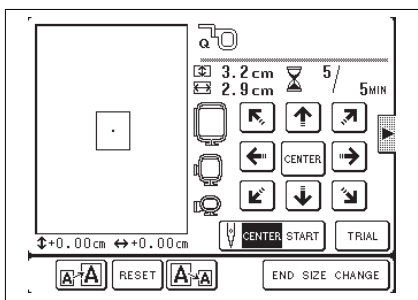

1. Touch the “SIZE” key.



2. To increase the pattern size, touch the “ ” key; to reduce the size, touch the “ ” key to reset the size touch the “ RESET ” key. The size will change each time one of these keys is pressed.

- * The maximum frame pattern size is different for each pattern.
- * Some frame patterns can be enlarged further if they are rotated 90°.

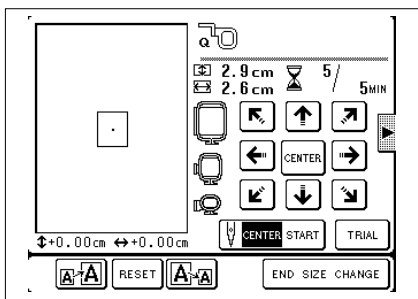

3. After adjustment is completed, touch the “END SIZE CHANGE” key.

CAUTION

After the size of a character, frame patterns or embroidery patterns have been changed, check the display to see which embroidery frames can be used. If an embroidery frame which is not displayed is used, the embroidery foot may touch the frame, or injury may result.

- * There are some patterns that cannot be enlarged or reduced.
- * Use the standard needle size if the thread breaks or splits when using reduced patterns change to a finer needle.
- * Use the standard embroidery thread weight, if gaps become obvious when using enlarged patterns change to a heavier weight thread.

ADJUSTMENTS DURING THE EMBROIDERY PROCESS

If the thread breaks during embroidering HELP

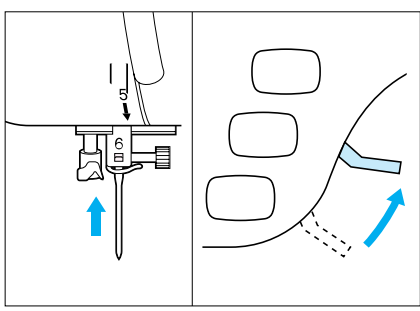

1. Stop the machine, raise the needle and the presser foot lever and re-thread the upper thread.

If the bobbin thread has broken

- 1 Cut the upper thread and remove the embroidery frame.
- 2 Check the under side of the embroidery for any thread build-up, clean.
- 3 Reset the bobbin thread and re-attach the embroidery frame.

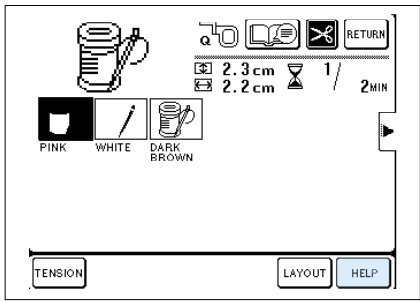

2. Touch the "HELP" key.

- ① The needle will return to the start position for the whole pattern.
- ② The needle will return to the start position for the color (or character) currently being embroidered (without embroidering).
- ③ The needle will proceed to the start position for the next color (or character) to be embroidered (without embroidering).
- ④ The needle will move back one stitch (without embroidering). If this key is touched continuously, the needle will move back in jumps of 17 stitches starting from the 6th stitch.
- ⑤ The needle will move forward one stitch (without embroidering). If this key is touched continuously, the needle will move forward in jumps of 17 stitches starting from the 6th stitch.
- ⑥ The display will return to the original screen (sewing screen).

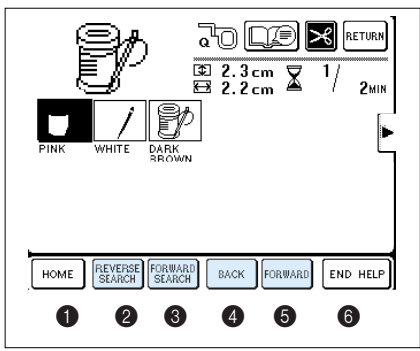

3. Touch the "BACK" key to move back a short way past the point where the thread broke.

* If the machine stops moving backward before you reach the point where you need to resume embroidering, touch the "REVERSE SEARCH" key and the "FORWARD" key. When you reach the point at which you would like to resume embroidering press the "START/STOP" button.

4. Lower the presser foot lever and start embroidering.

* The "START/ STOP" button may not function for a few seconds after the "FORWARD SEARCH" or "REVERSE SEARCH" key is touched, however this is not a sign of a malfunction.

Continuing a pattern after the power has been momentarily turned off HELP

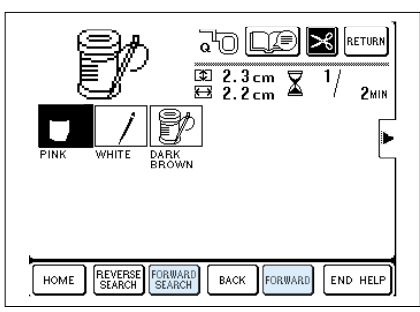

Example: Continuing to embroider halfway through the second color

1. Select the pattern and then touch the "HELP" key.
 2. Touch the "FORWARD SEARCH" key to move to the start of the second color.
 3. Touch the "FORWARD" key to move forward to a position slightly before the point where embroidering is to continue.
 4. Lower the presser foot and start embroidering.
- * When moving the embroidering position on the layout screen before continuing to embroider the pattern, move the position on the layout screen by the same amount before carrying out the above procedure.

When sewing again from the beginning HOME

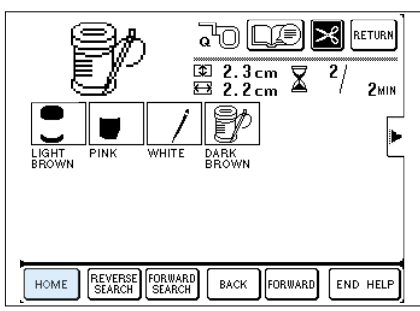

1. Touch the “HOME” key. The needle will return to the embroidery start position.
2. Lower the presser foot lever and start embroidering.

EMBROIDERY APPLICATIONS

Linking characters

Use this feature when the characters cannot be sewn all at once.

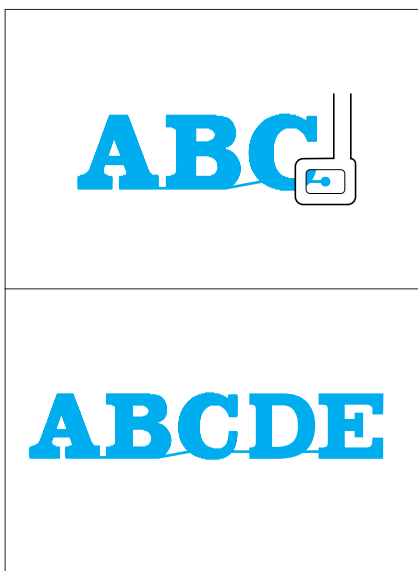
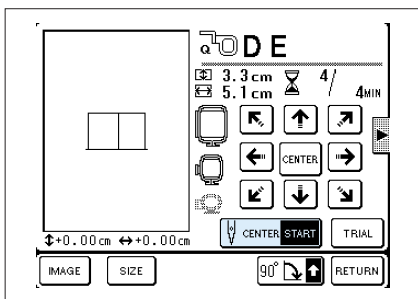
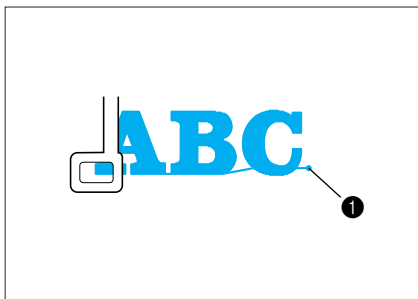
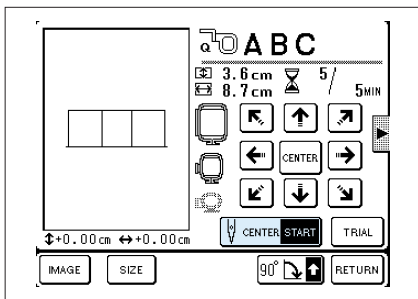

Example: Embroidering ABC, then linking DE

1. Touch "A", "B", and "C", touch the "LAYOUT" key to move the needle to the center position, and then touch the "CENTER START" key.

2. Press the "START/STOP" button and start embroidering. Once embroidering is completed, move the fabric to the position where "DE" is to be embroidered.

① The embroidery end position

* Match the line of embroidery with reference lines on the embroidery sheet that fits the frame you are using.

3. Select "DE", then touch the "LAYOUT" key, and touch the "CENTER START" key to highlight START.

4. Use the arrow keys to move the needle to the embroidery end position for "ABC".

5. Press the "START/STOP" button and start embroidering.

Embroidering appliques (using a frame pattern)

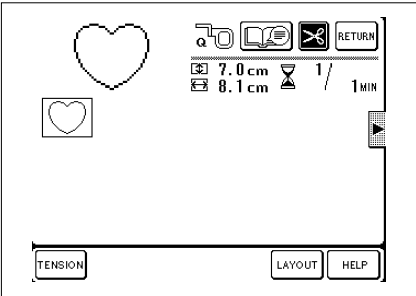

You can use frame patterns with the same shape and size to sew appliques.

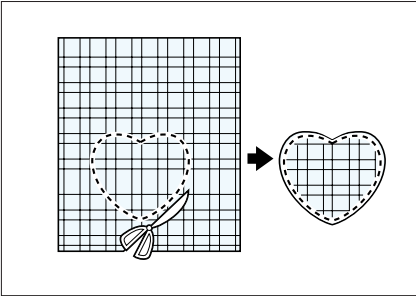

1. Select the applique material for the project, attach a stabilizer material, place it into the embroidery frame and attach the embroidery frame to the machine.

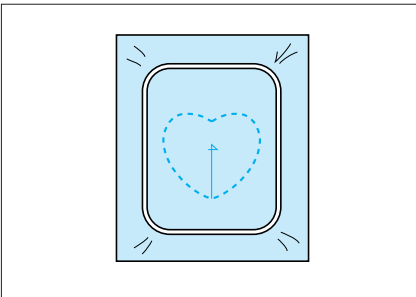

2. Select the frame shape to be embroidered and select the “” stitch. Embroider onto the applique material. Remove the fabric from the embroidery frame. Cut neatly around the outside of the shape made by the stitches.

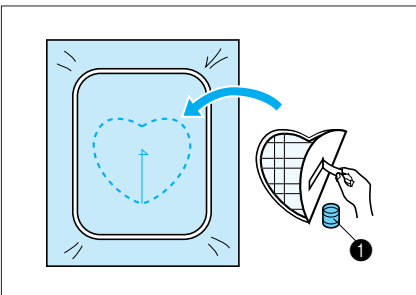

3. Embroider a base fabric in the same way using the same frame pattern shape and the “” stitch as in step 2.

4. Apply a thin layer of fabric glue to the rear of the applique material which is created in step 2, and then attach it to the base fabric so that it follows the frame shape just stitched.

① Fabric glue

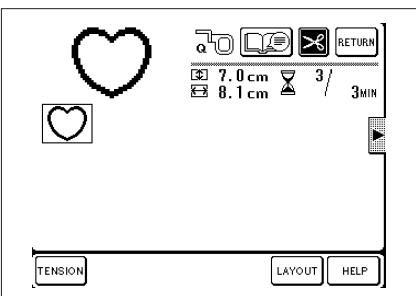

5. Without changing the frame shape or size, select the “” stitch, and use it to embroider the applique material onto the project.

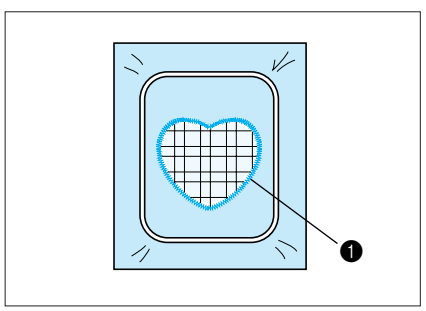

1 Satin stitch “ 1 ”

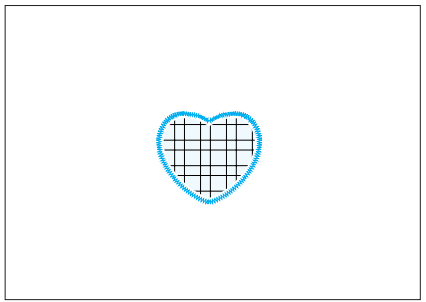

Finished applique on the project

Embroidering onto small pieces of fabric or onto corners

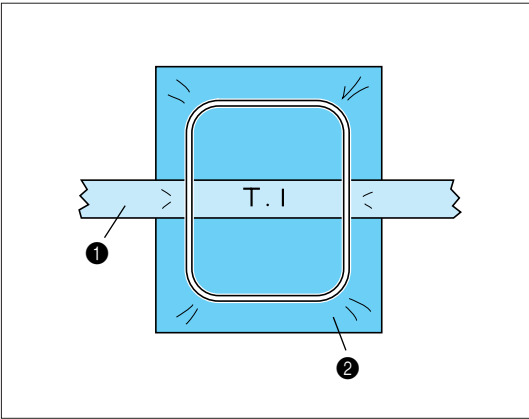
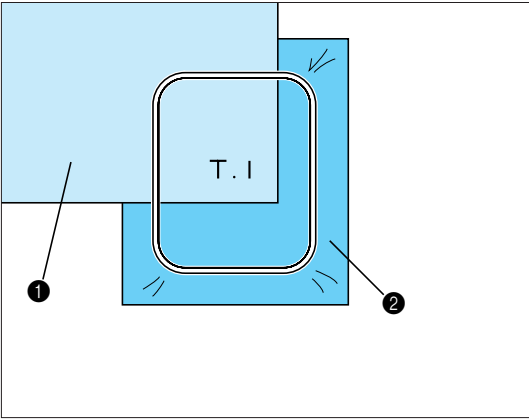
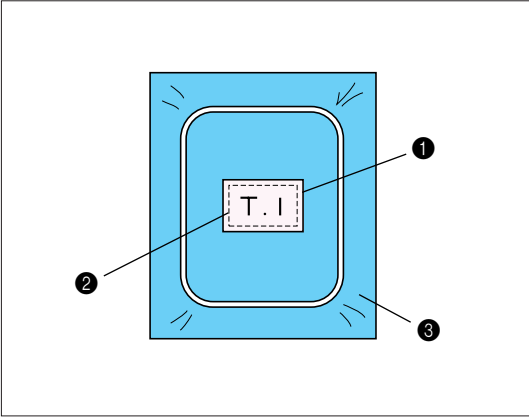

Use stabilizer fabric to provide extra support while embroidering. After embroidering is completed, remove the stabilizer fabric carefully. Use stabilizer fabric which is designed specially for embroidering.

Case A

- ① Fabric
- ② Attach the stabilizer fabric by ironing. (If you do not wish to iron, attach the stabilizer fabric with a basting stitch.)
- ③ Stabilizer

Case B

- ① Fabric
- ② Stabilizer

Case C

- ① Ribbon (Secure with double-sided tape)
- ② Stabilizer

NOTE

Temporary spray on adhesive will also enable you to tack down unusually shaped objects. Some glue may get onto the presser foot, needle and needle plate at this time. Finish embroidering the applique pattern and then clean away the glue.

5. EMBROIDERY EDITING

EMBROIDERY EDITING CAPABILITIES

Embroidery editing lets you change the pattern layout by rotating and moving the pattern within an 18 cm long x 13 cm wide embroidery area. Also positioning is easy when combining one point patterns with characters and when sewing characters on a curved line. Use the “EMBROIDERY EDIT” key to combine patterns and characters or two or more patterns so that you can make your very own original emblems or name tags.

Explanation of the Editing Functions

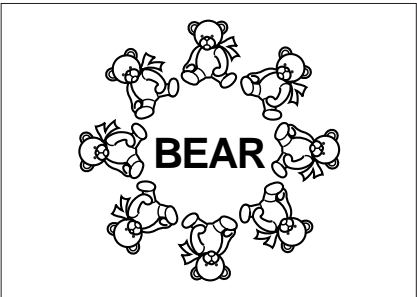

Layout (Movement)

Patterns can be moved to a desired position within the 18 cm long x 13 cm wide embroidery area by using the edit function and confirming the position on the liquid crystal display (LCD) screen.



Combinations

Combining one-point patterns with border patterns, characters and embroidery card patterns is easy.



Rotation

Directional position of patterns and characters can be changed by rotating them in 5-degree steps.

Expansion and Reduction

Up to 50 increments size changes can be made to characters and border patterns.

Configurations

Up to 6 different types of character configuration can be selected.

Other Useful Functions

- One-point patterns can be mirror imaged in the left or right direction.
- The space between characters can widened or closed.

HOW TO EDIT

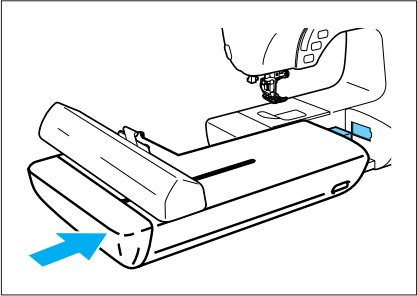

1. Attach the embroidery unit and make necessary preparations before Embroidering.
 * See pages 106 to 108 for details.

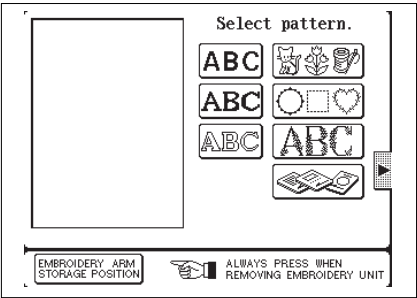

2. Press the “EMBROIDERY EDIT” key to display the following screen.

Character Editing

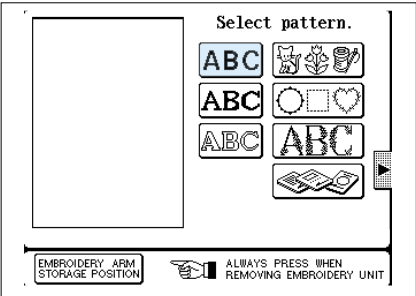

Example: Editing the Alphabet "ABCDEFG"

1. Select character type.

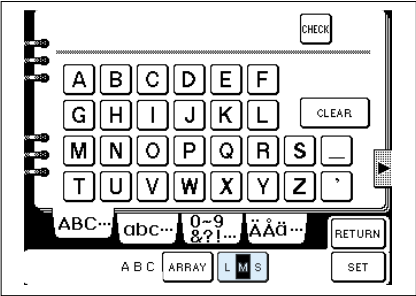

2. First, designate the character size. (If you select hiragana/katakana, also designate vertical characters or horizontal characters at the same time.)

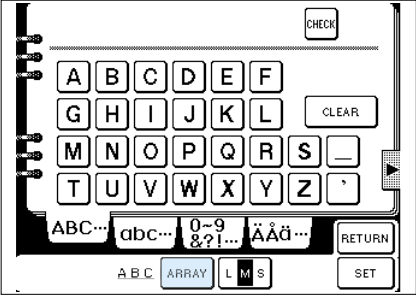

3. Next, select character configuration.

Press the "ARRAY" key.

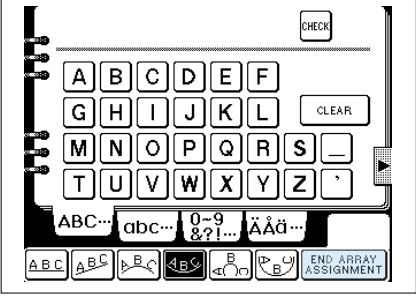

4. Select configuration type.

After making your selection, press the "END ARRAY ASSIGNMENT" key.

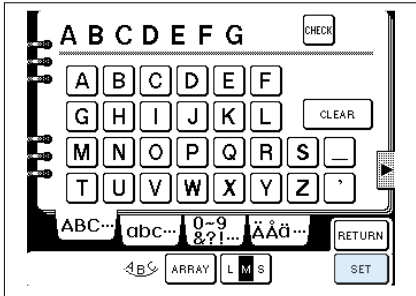

5. Select character, then press the “**SET**” key.

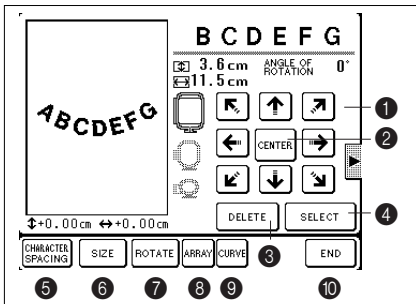

After a while the characters will be displayed. The characters will be laid out in the center of the embroidery area.

- ① Press these keys to move patterns in the direction of the arrows. (See page 139 for details.)
- ② Press this key to bring the pattern back to the center of the embroidery area.
- ③ Press this key to delete the pattern being edited. (See page 141 for details.)
- ④ Use this key to change the pattern to be edited.
- ⑤ Use this key to change character spacing. (See page 139 for details.)
- ⑥ Use this key to change character size. (See page 140 for details.)
- ⑦ Use this key to rotate characters to the right or left in 5-degree steps. (See page 140 for details.)
- ⑧ Press this key when you want to change character configuration. (See page 141 for details.)
- ⑨ Press this key when you want to change the extent of a curve. (See page 141 for details.)
- ⑩ Press this key to move to the next stage.

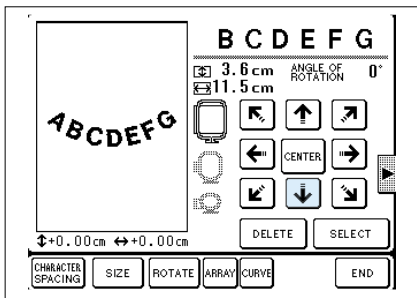

Moving Characters

Press the key marked with the arrow pointing in the direction you want to move the character.

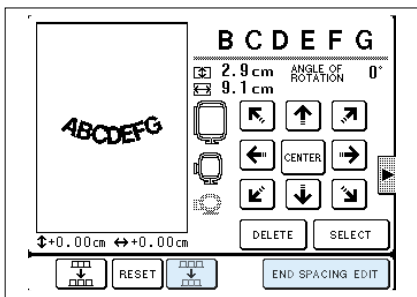
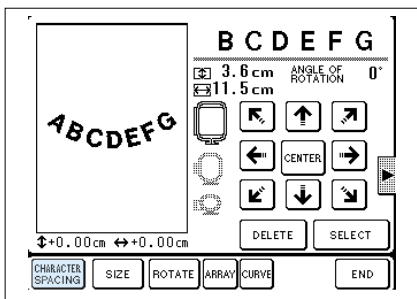
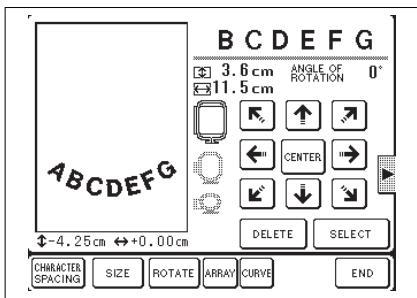

Spacing Characters

Press the "CHARACTER SPACING" key to alter character spacing.

Press the " " key to open the space between characters.

Press the " " key to close the space between characters.

Press the "END SPACING EDIT" key when character spacing is completed.

Press the "RESET" key to revert back to the original character spacing.

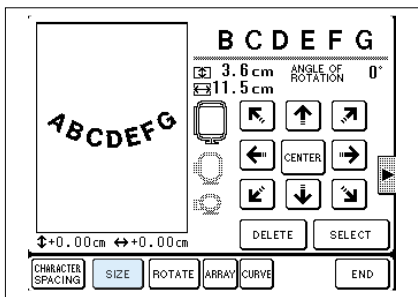

Changing Character Size

Press the "SIZE" key to alter character sizes.

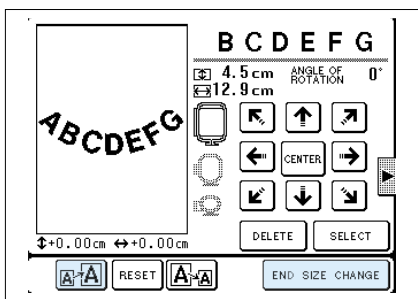

Press the "A+" key to increase character size.

Press the "A-" key to decrease character size.

Press the "END SIZE CHANGE" key when Changing of character size is completed.

Press the "RESET" key to revert back to the original character size.

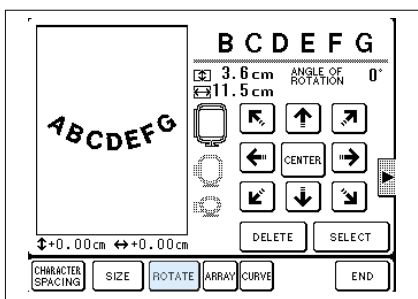

Rotating Characters

Press the "ROTATE" key to rotate patterns.

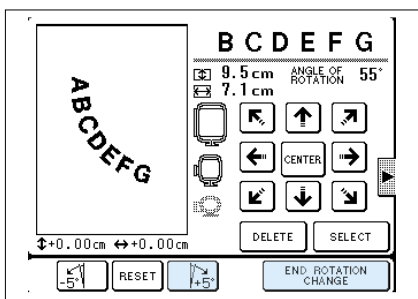

The pattern will rotate 5 degrees to the right each time the "5°" key is pressed.

The pattern will rotate 5 degrees to the left each time the "5°" key is pressed.

Press the "END ROTATION CHANGE" key when pattern rotation is completed.

Press the "RESET" key to revert back to the original rotation angle.

NOTE

The angle of rotation that you have currently selected is displayed on the screen at this time.

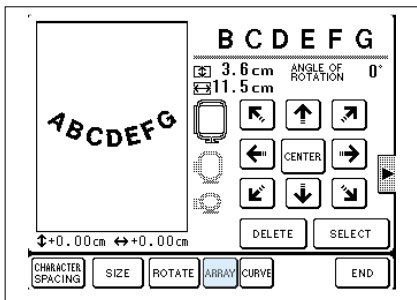

Changing Configurations

Press the “**ARRAY**” key to change configuration.

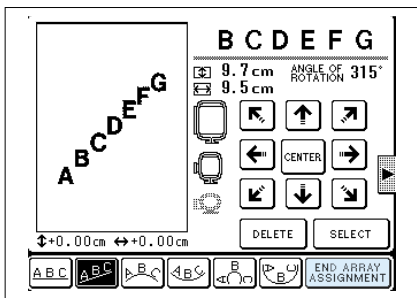

Select the type of Configuration.

After selecting configuration type, press the “**END ARRAY ASSIGNMENT**” key.

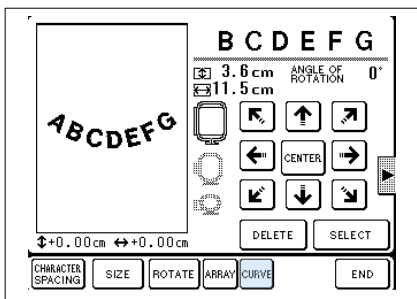

Changing the Extent of the Curve

The “**CURVE**” key is displayed when curve configuration is selected.

Press the “**CURVE**” key.

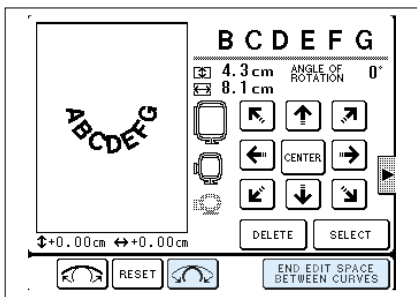

The curve becomes more pronounced each time the “**CURVE**” key is pressed.

The curve becomes less pronounced each time the “**RESET**” key is pressed.

Press the “**END EDIT SPACE BETWEEN CURVES**” key when curve changing is completed.

Press the “**RESET**” key to revert to the original curve.

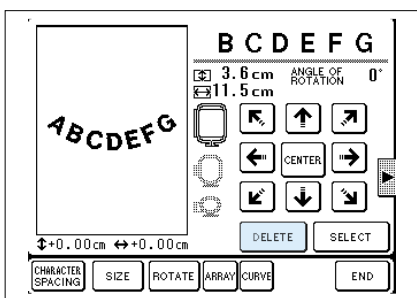

Deleting a Pattern being Edited

Press the “**DELETE**” key to delete a pattern currently being edited. The pattern will disappear from the edit screen.

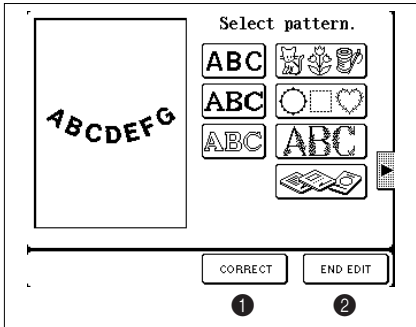
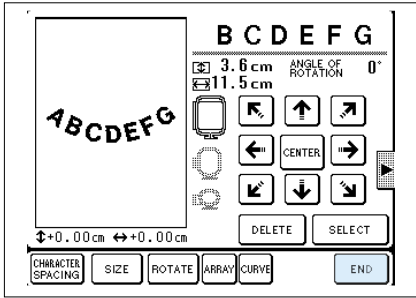

Completing Edit Work

Press the “END” key when editing is completed.

The edited pattern is displayed on the edit screen. Select pattern type if another pattern is to be edited at this point.

- ① Press this key when you want to correct an edited pattern. (See page 154 for details.)
- ② Press this key when editing is completed.

One-point Editing

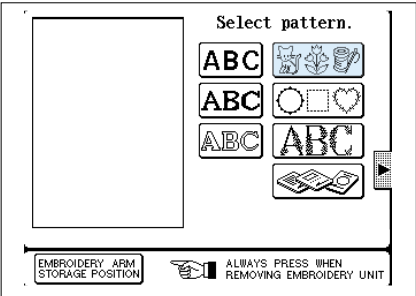

1. Select the one-point type.

Example:

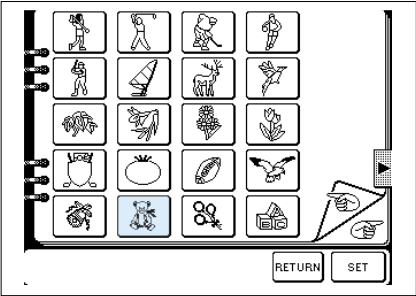

2. Select embroidery pattern.

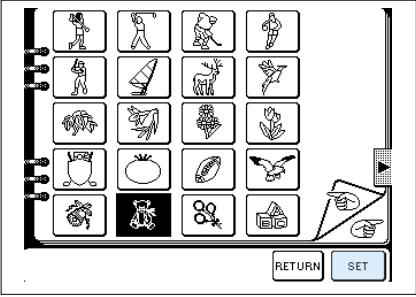

3. Designate size, then press the "SET" key.

* "L S" is displayed when there are 2 pattern sizes and "L M S" is displayed when there are 3 pattern sizes. Select a size.

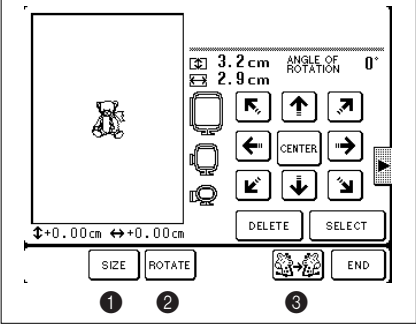

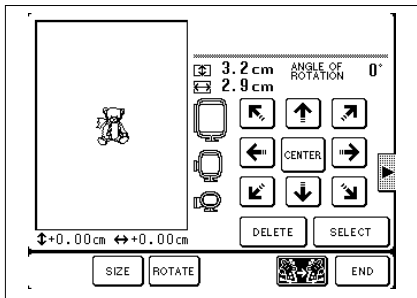
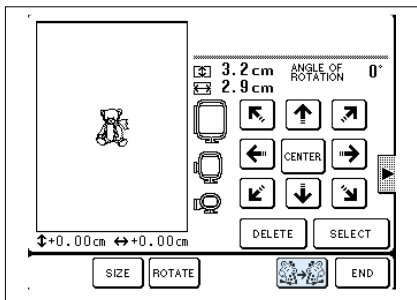

After a while the characters will be displayed on the edit screen.

- ① The pattern changes size of the pattern.
- ② The pattern rotates 5 degrees to the left or right with each press of this key. (See page 140 for details.)
- ③ Use this key to mirror image the pattern to the left or right.



Mirror Imaging Patterns to the Left or Right

Press the “” key to mirror image patterns to the left or right.

* Sometimes the “” key is not displayed due to the pattern selected.

See pages 139 to 142 for details on other editing methods.

Border Pattern Editing

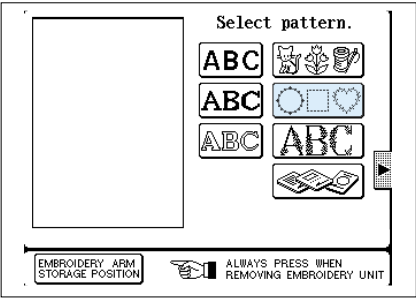

1. Select border pattern.

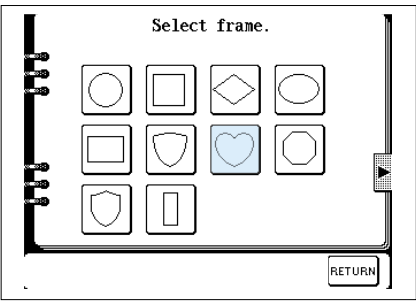

2. Select border shape.

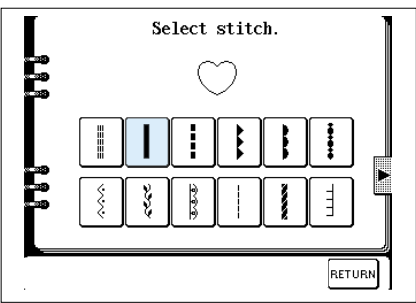

3. Select stitching style.

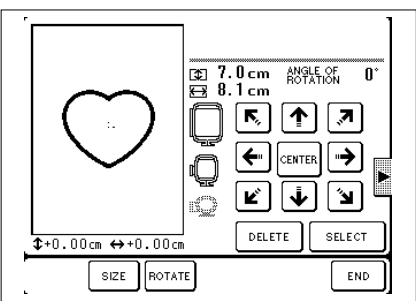

4. The selected border pattern will be displayed on the edit screen. (See pages 139 to 142 for details on editing methods.)

- ① Use this key to change the size of the pattern. (See page 140 for details.)
- ② Use this key to rotate the pattern.

① ②

Editing Patterns on Embroidery Cards (sold separately)

Note
Only insert or remove embroidery cards when "  " is displayed.

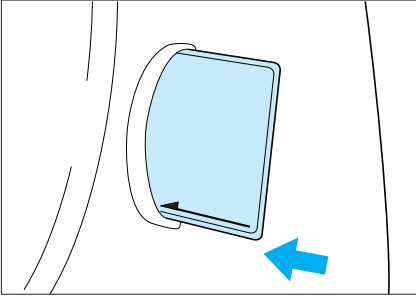

Example: Editing Patterns on the "Flower Card" (sold separately)

1. Fully insert the embroidery card (with the card arrow, found on the front side, pointing in the direction of the slot) into the card slot found on the side of your machine.

Note
Do not try to insert the card in any other direction than that of the card arrow and do not try to forcefully insert the card as either of these actions may cause damage.

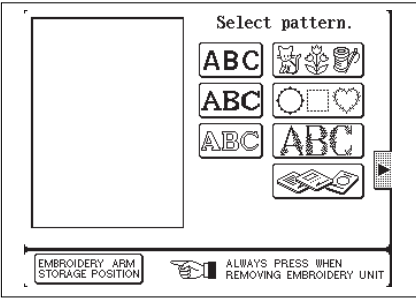

2. Press the "Embroidery Edit" key followed by the "  " key to display the pattern selection screen for the embroidery card.

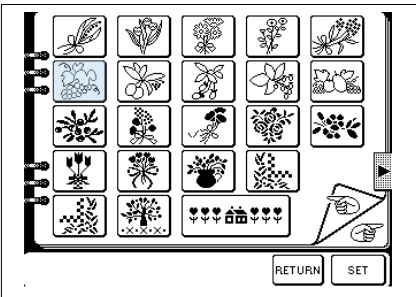

3. Select a pattern, then edit. (See pages 135 to 142 for details on editing methods.)

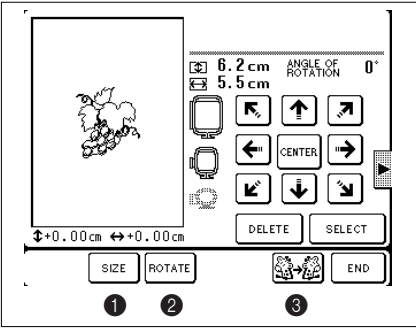

- ① Use this key to change size of pattern. (Refer page 140)
- ② Use this key to rotate the pattern. (See page 140 for details.)
- ③ Use this key to mirror image the pattern to the left or right. (See page 144 for details.)

Editing Combinations

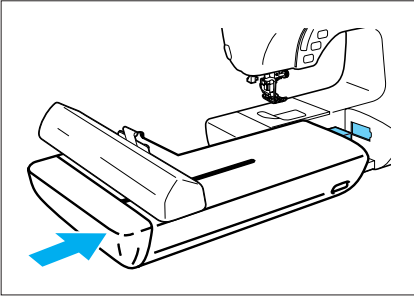

Example: Editing the “BEAR BEAR” alphabet characters with stitching pattern in one location.

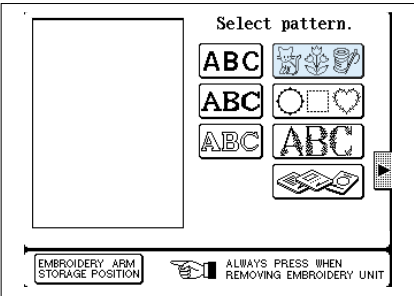

1. Attach the embroidery unit and carry out pre-embroidery preparations. (See Page 106 to 108 for details.)

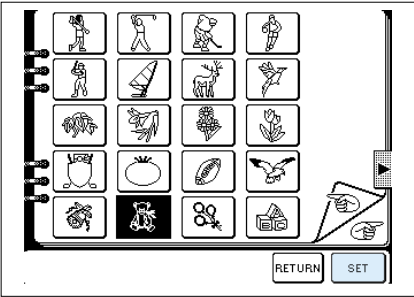

2. Press the "Embroidery Edit" key.
The available types of stitching patterns will be displayed.

3. Press “”.



4. Select “”, and press “”.
Item “” will be called up.

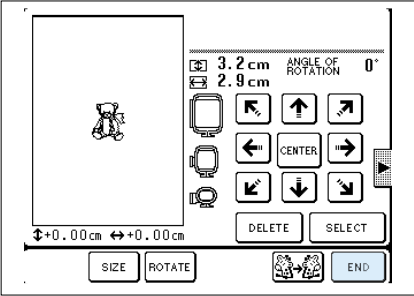

5. The embroidery pattern will be laid out in the center of the embroidery area.
Press “”.

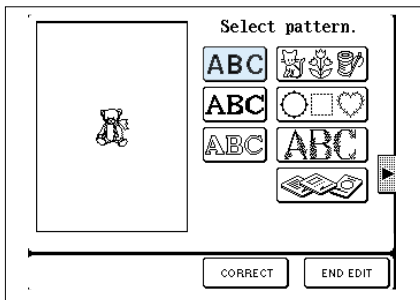

6. Select alphabet characters.
 Press "ABC".

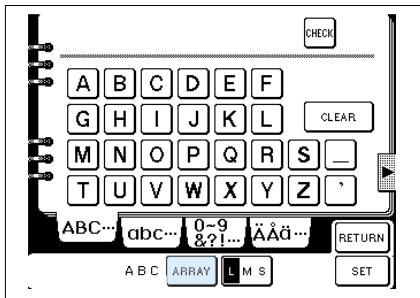

7. Specify alphabet character size, then select "ARRAY".

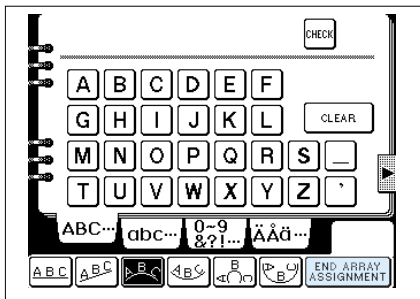

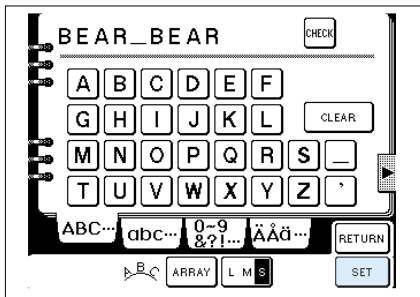

8. Select "ABC", then press "END ARRAY ASSIGNMENT".

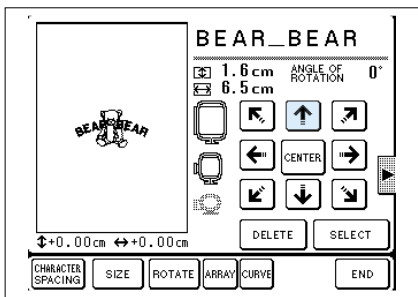

9. Input "BEAR BEAR", then press "END".





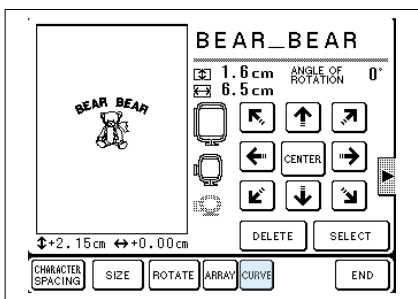

10 Press “” to move the alphabet characters upwards to a position that is well balanced with the “”.

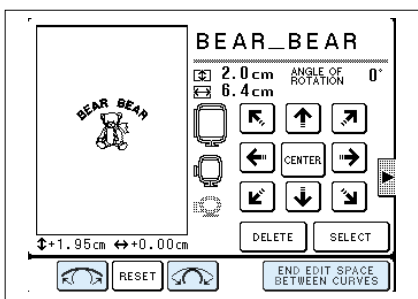



11. Press “” when you would like to adjust the degree of the alphabet character array curve.

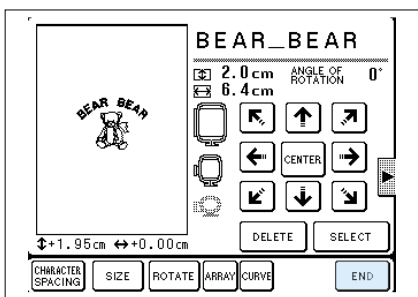

12. Press “” and “” to adjust the degree of the alphabet character array curve, and press “” when all adjustments are completed.

* Press “” to return to initial status.



13. Press “”.

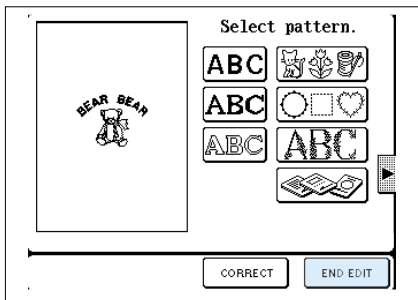

14. Finish editing.

Press " END EDIT ".

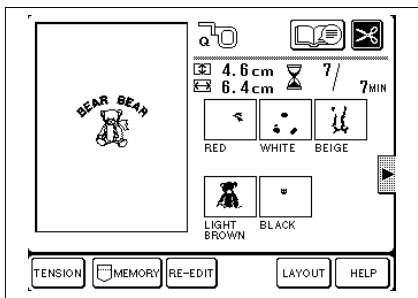

15. The "SEWING" screen will be displayed. (See page 153 for details on sewing.)

SAVING A PATTERN COMBINATION TO MEMORY

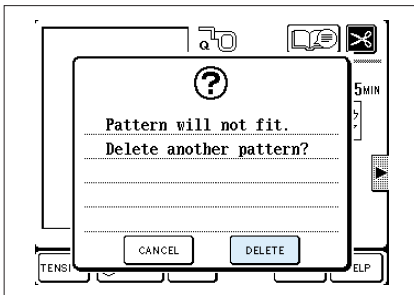
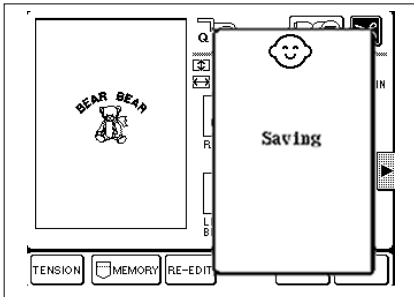
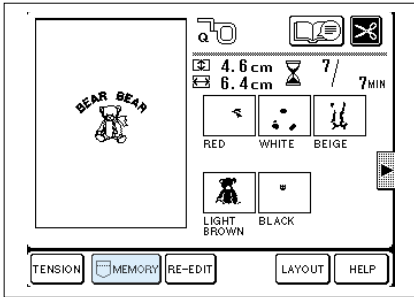

You can save up to 15 different patterns in the memory. However, if some of the patterns contain large amounts of data, it may not be possible to save the whole 15 patterns.

1. Touch the “MEMORY” key.

2. The word “SAVING” will appear on the screen. After the pattern is saved, the display will return to the original screen.

Refer to page 156 for details on how to retrieve characters and patterns which have been saved to memory.

* Do not turn off the power while the word “Saving” is displayed on the screen.

If you turn off the power during this time, the data being saved may be deleted.

If no more patterns can be saved

There are already 15 patterns in the memory. The data currently stored has filled the entire memory area. To delete a pattern that is already saved in the memory, touch the “DELETE” key. To cancel the saving of a pattern, touch the “CANCEL” key. The saving process will continue.

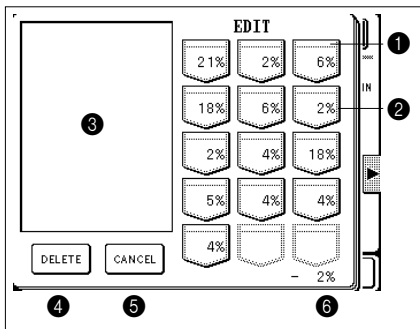

Deleting a stored pattern

1. If you touch the “DELETE” key, a screen similar to the one shown at the left will be displayed.

- ① This indicates a pocket which has a pattern saved in it.
- ② This indicates the amount of data in the pattern.
- ③ This displays the pattern which is saved in that pocket.
- ④ Touch this key to delete a saved pattern.
- ⑤ Touch this key to cancel the deleting of a pattern.
- ⑥ This indicates how much data space is needed.

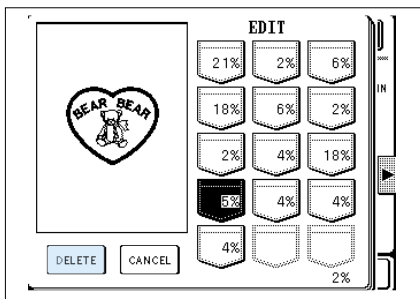

2. Touch the pocket to select the pattern to be deleted, and then touch the “DELETE” key.

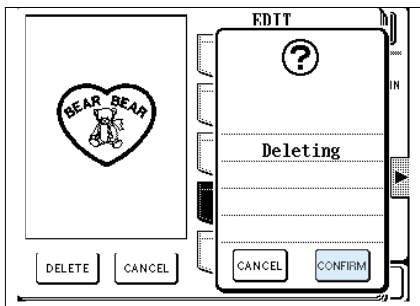

3. Touch the “CONFIRM” key.
If the amount of space needed becomes available then the new pattern will be saved automatically. If there still is not enough space to save the pattern, repeat the above procedure to delete another pattern.

* To cancel the deleting of a pattern, touch the “CANCEL” key.

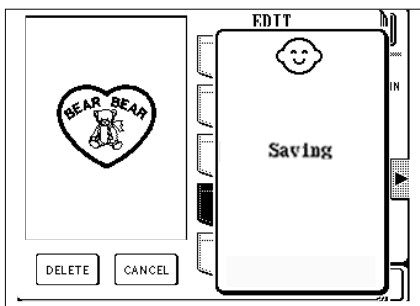

* Do not turn off the power while the word “Saving” is displayed on the screen.
If you turn off the power during this time, the data being saved may be deleted.

Let's Sew

Note: Be sure to thoroughly read page 120 and 121 ("Embroidery" and "Sewing") before sewing.

CAUTION

Always check the layout screen display (see page 117 for details) before using the medium-size and small-size embroidery frames (sold separately). Misuse will lead to the application of pressure to the embroidery frame, and may cause injuries.

Start sewing in the edited order. In this case the "🐻" stitch pattern followed by the "BEAR BEAR" alphabet characters.

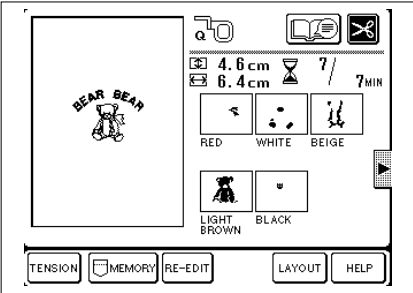

1. Press "END EDIT" and the next screen will be displayed.

First, sew the "🐻". Sew in accordance with the order of color changes displayed.

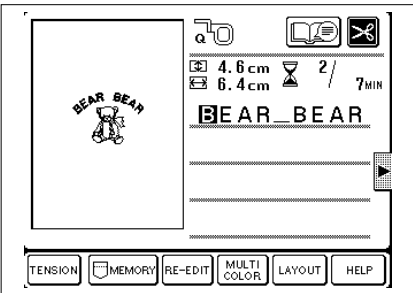

2. The next screen will be displayed when sewing is completed. Next, sew the "BEAR BEAR" alphabet characters.

* Press "MULTI COLOR", and the machine will stop after each character is sewn, so that the color can be changed for individual characters.

CORRECTING EDITED PATTERNS

Correcting another stitch pattern during editing

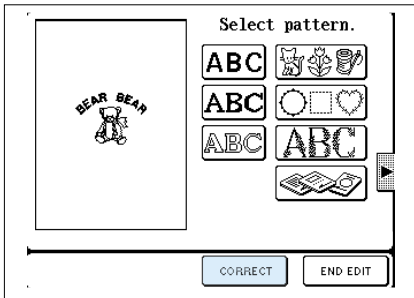

If you want to correct another pattern while using the editing tool, press the “**CORRECT**” key when the screen on the left is being displayed to return to the edit screen.

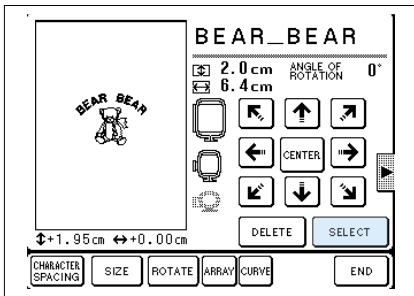

Example: Changing a Character Configuration when Editing a Border.

1. Press the “**SELECT**” key at the edit screen to enable selection of edited patterns.
Press the “**SELECT**” key, then select a character.
- * The selected pattern will appear darker than other patterns.

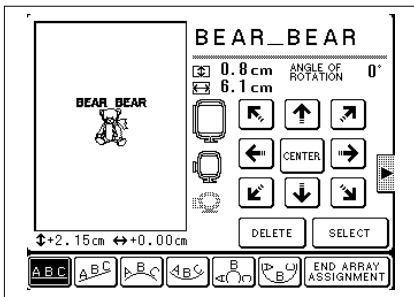

2. Press the “**ARRAY**” key, then change the configuration of the character.
- * Press the “**SELECT**” key again if you want to make corrections to another pattern.

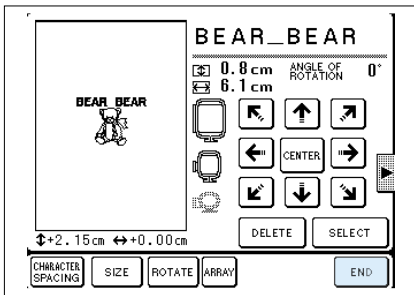

3. Press the “**END**” key when corrections are completed.

Setting Up

Sewing

Utility Stitches

Characters and Decorative Stitches

Embroidering

Editing Embroidery Patterns

Retrieving

My Custom Stitch™

Maintenance

Error Messages

Trouble shooting

Sewing Chart

Patterns (Programmed in Machine)

Patterns (Memory Card)

Correcting stitch patterns after editing

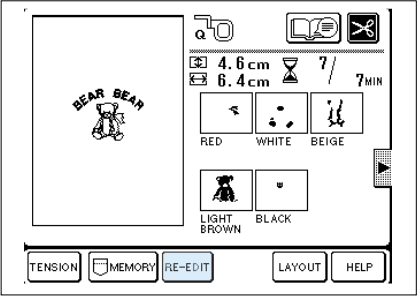

Press the "RE-EDIT" key to make corrections after editing has been completed. (See page 154 for details on correction methods.)

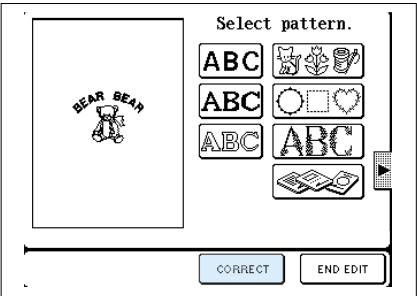

6. RETRIEVING

RETRIEVING CHARACTERS AND PATTERNS

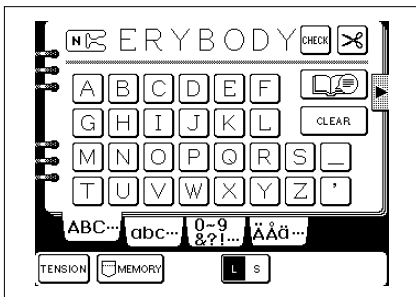
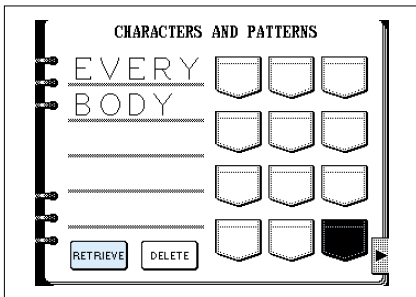
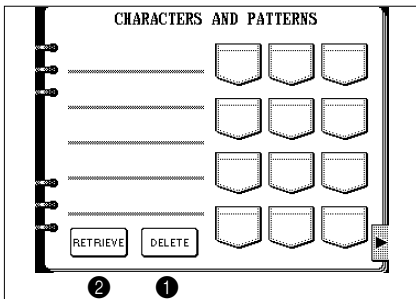
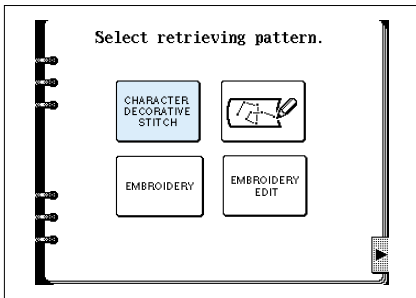
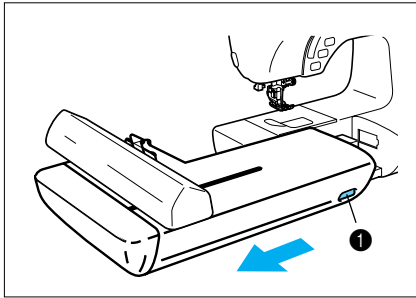

This machine has three memory function areas; one is found on the sewing side of the machine and the other two are found on the embroidery side of the machine. Sewing function: saves a variety of characters, patterns, decorative stitches and designs from MY CUSTOM STITCH™ (Allows you to create your own stitches). Embroidery function: saves characters and memory card patterns when using the embroidery or embroidery edit function.



Preparation:

Remove the embroidery unit if retrieving patterns saved on the sewing side of the machine.

1 Release button

* Make sure that the power is turned off before doing this.

1. Touch the “MEMORY RECALL” key.
A screen such as the left will be displayed.
2. Touch the “CHARACTER DECORATIVE STITCH” key.

The “” symbol indicates a pocket which has a pattern saved in it. Touch the “” to display the saved pattern.

- 1 Touch this key to delete the saved pattern.
- 2 Touch this key to retrieve the saved pattern.

3. Touch the pocket in order to retrieve the desired patterns, and then touch the “” key.

4. The patterns will then be retrieved.

RETRIEVING AN EMBROIDERY PATTERN

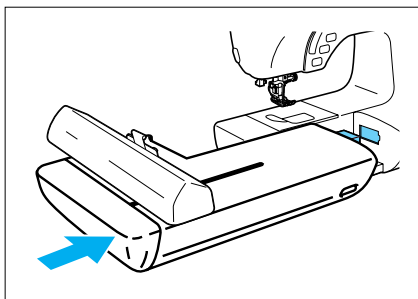

Preparation:

Attach the embroidery unit.

- * Make sure that the power is turned off before doing this.

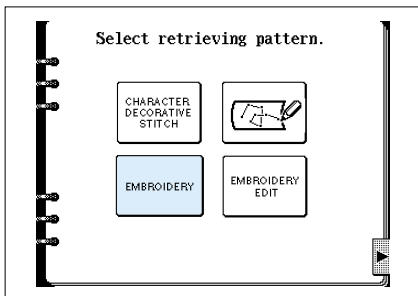

1. Touch the "MEMORY RECALL" key. A screen such as the left will be displayed.
2. Touch the "EMBROIDERY" key.

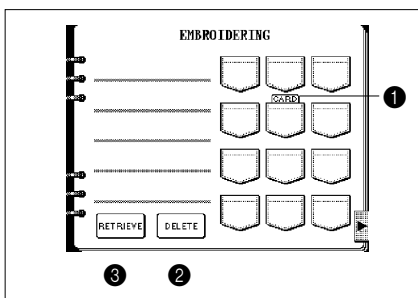

The "☐" symbol indicates a pocket which has a pattern saved in it. Touch the pocket to display the saved pattern.

- 1 The display will indicate that the patterns are saved on the memory card. Touch after inserting the memory card on which the pattern is saved.
- 2 Touch this key to delete the saved pattern.
- 3 Touch this key to retrieve the saved pattern.

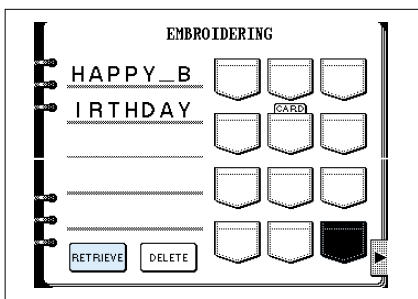

3. Touch the pockets in order to retrieve the desired patterns, and then touch the "RETRIEVE" key.

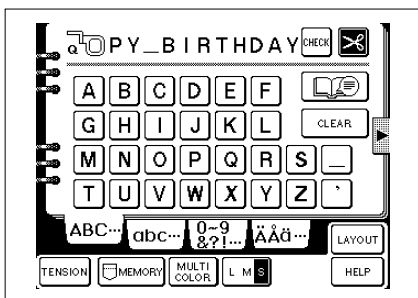

4. The characters or patterns will then be retrieved.

RETRIEVING AN EDITED PATTERN

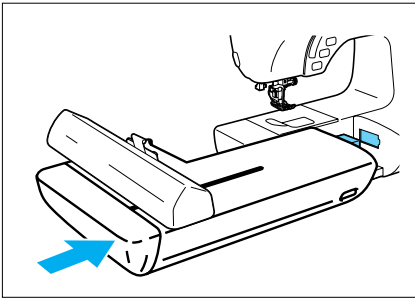

Preparation:
Attach the embroidery unit.

* Make sure that the power is turned off before doing this.

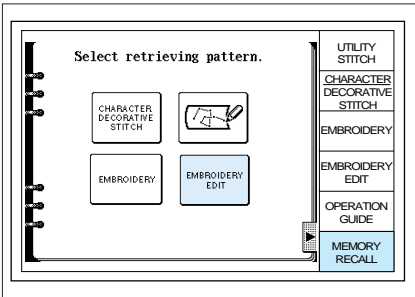

1. Touch the "MEMORY RECALL" key.
A screen such as the left will be displayed.
2. Touch the "EMBROIDERY EDIT" key.

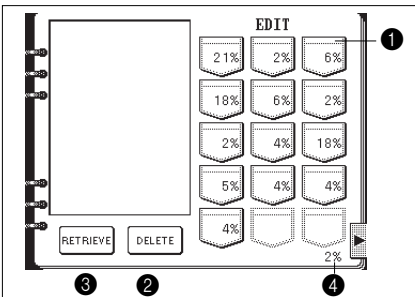

The "☐" symbol indicates a pocket which has a pattern saved in it. Touch the pocket to display the saved pattern.

- ① The numbers indicate the amount of data for each pattern.
- ② Touch this key to delete the saved pattern.
- ③ Touch this key to retrieve the saved pattern.
- ④ This indicates how much data space remains.

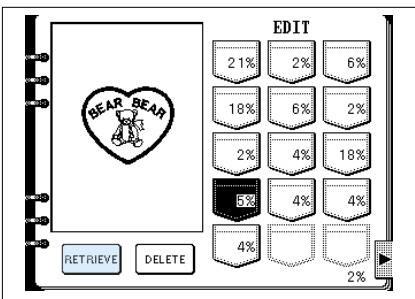

3. Touch the pocket in order to retrieve the desired patterns, and then touch the "RETRIEVE" key.

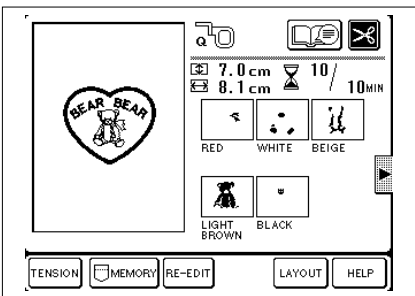

4. The patterns will then be retrieved.

* The retrieved patterns can then be re-edited. (Refer to page 155.)

DELETING A STORED PATTERN

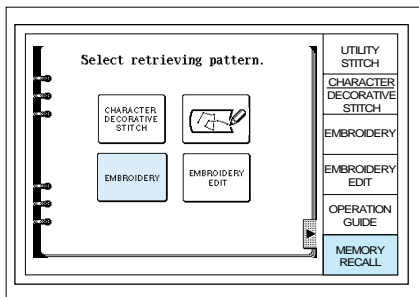

Example: Deleting an embroidery pattern

1. Press the “MEMORY RECALL” button.
2. Touch the “EMBROIDERY” key.

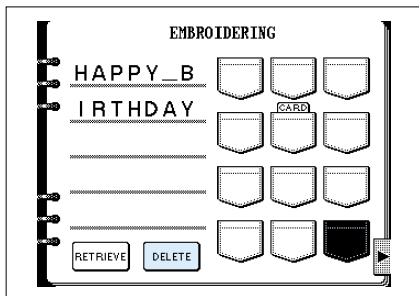

3. Touch a pocket to select the pattern to be deleted, and then touch the “DELETE” key.

* To delete a pattern which is stored inside a pocket on a memory card, that particular memory card must be inserted into the machine at the time.

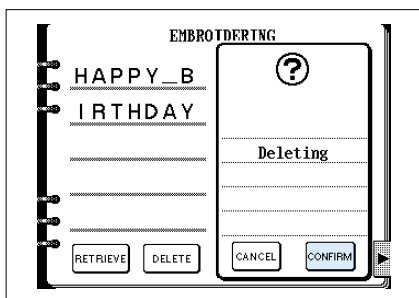

4. Touch the “CONFIRM” key.

* If you touch the “CANCEL” key, the display will return to the original screen.

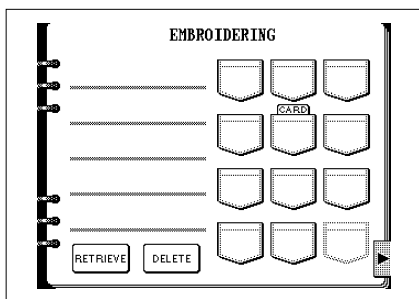

7. MY CUSTOM STITCH™ (CREATE YOUR OWN STITCH DESIGNS)

MAKING THE ILLUSTRATION

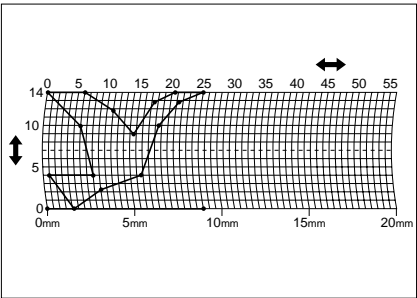
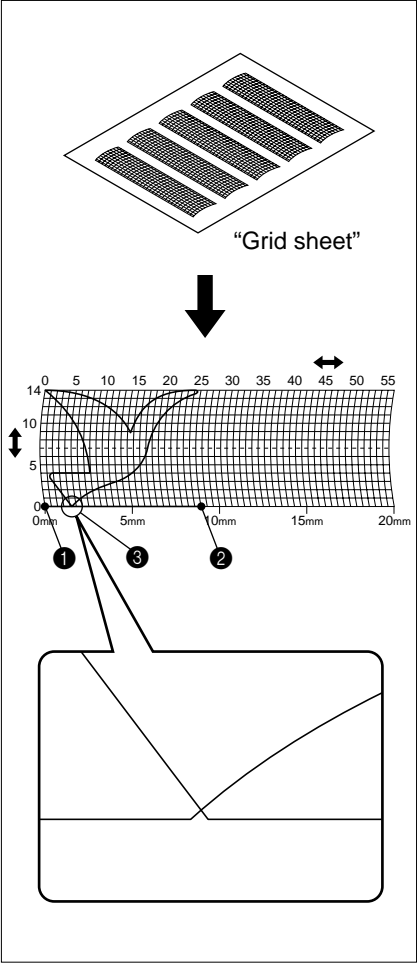

You can use the “MY CUSTOM STITCH™” to sew patterns that you have drawn yourself.

- * Illustrations that are to be used with the “MY CUSTOM STITCH™” can be a maximum of 7 mm wide and 33 mm long.
- * Patterns for the “MY CUSTOM STITCH™” can be drawn more easily if you use the included grid sheet.

1. Draw the illustration onto the grid sheet (SA500, X80948-001).

- ① Start point
- ② End point
- ③ Intersection

* Simplify the drawing so that it can be drawn as a continuous line. If sewing continuous patterns, the height of the start point and end point should be the same. You can obtain a more attractive finish if you make the intersections cross over to make a closed design.

2. Mark coordinate points at each point in the pattern where the direction of the stitching changes, this will maintain the shape of the pattern as it is sewn.



| Stitch | 1 | 2 | 3 | 4 | 5 | 6 | 7 | 8 | 9 | 10 | 11 | 12 | 13 | 14 | 15 |
|--------|----|----|----|----|----|----|----|----|----|----|----|----|----|----|----|
| ↔ | 00 | 12 | 18 | 22 | 23 | 21 | 17 | 14 | 12 | 09 | 06 | 03 | 01 | 03 | 06 |
| ↕ | 00 | 00 | 03 | 06 | 10 | 13 | 14 | 13 | 11 | 13 | 14 | 13 | 10 | 06 | 03 |
| Stitch | 16 | 17 | 18 | 19 | 20 | 21 | 22 | 23 | 24 | 25 | 26 | 27 | 28 | 29 | 30 |
| ↔ | 12 | 41 | 43 | 40 | 41 | 38 | 35 | 32 | 30 | 32 | 35 | 41 | 45 | 47 | 44 |
| ↕ | 00 | 00 | 04 | 07 | 11 | 13 | 14 | 13 | 10 | 06 | 03 | 00 | 00 | 04 | 07 |
| Stitch | 31 | 32 | 33 | 34 | 35 | 36 | 37 | 38 | 39 | 40 | 41 | 42 | 43 | 44 | 45 |
| ↔ | 45 | 47 | 50 | 54 | 56 | 55 | 51 | 45 | 70 | | | | | | |
| ↕ | 11 | 13 | 14 | 13 | 10 | 06 | 03 | 00 | 00 | | | | | | |



| Stitch | 1 | 2 | 3 | 4 | 5 | 6 | 7 | 8 | 9 | 10 | 11 | 12 | 13 | 14 | 15 |
|--------|----|----|----|----|----|----|----|----|----|----|----|----|----|----|----|
| ↔ | 00 | 30 | 32 | 32 | 32 | 33 | 35 | 35 | 37 | 35 | 32 | 30 | 30 | 29 | 26 |
| ↕ | 00 | 00 | 01 | 07 | 10 | 12 | 11 | 08 | 12 | 14 | 14 | 11 | 05 | 03 | 08 |
| Stitch | 16 | 17 | 18 | 19 | 20 | 21 | 22 | 23 | 24 | 25 | 26 | 27 | 28 | 29 | 30 |
| ↔ | 24 | 18 | 13 | 12 | 13 | 10 | 12 | 08 | 12 | 07 | 12 | 06 | 10 | 05 | 10 |
| ↕ | 10 | 13 | 14 | 14 | 12 | 11 | 10 | 09 | 08 | 06 | 06 | 03 | 02 | 00 | 02 |
| Stitch | 31 | 32 | 33 | 34 | 35 | 36 | 37 | 38 | 39 | 40 | 41 | 42 | 43 | 44 | 45 |
| ↔ | 16 | 19 | 23 | 22 | 17 | 22 | 23 | 19 | 42 | | | | | | |
| ↕ | 01 | 00 | 00 | 06 | 10 | 06 | 00 | 00 | 00 | | | | | | |

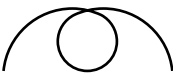

| Stitch | 1 | 2 | 3 | 4 | 5 | 6 | 7 | 8 | 9 | 10 | 11 | 12 | 13 | 14 | 15 |
|--------|----|----|----|----|----|----|----|----|----|----|----|----|----|----|----|
| ↔ | 00 | 03 | 05 | 08 | 12 | 17 | 20 | 24 | 27 | 29 | 31 | 32 | 30 | 27 | 24 |
| ↕ | 00 | 05 | 08 | 11 | 13 | 14 | 14 | 13 | 12 | 11 | 09 | 06 | 03 | 01 | 00 |
| Stitch | 16 | 17 | 18 | 19 | 20 | 21 | 22 | 23 | 24 | 25 | 26 | 27 | 28 | 29 | 30 |
| ↔ | 21 | 18 | 16 | 15 | 15 | 16 | 18 | 21 | 25 | 28 | 33 | 37 | 41 | 43 | 44 |
| ↕ | 00 | 01 | 03 | 05 | 08 | 10 | 12 | 13 | 14 | 14 | 13 | 11 | 08 | 05 | 00 |
| Stitch | 31 | 32 | 33 | 34 | 35 | 36 | 37 | 38 | 39 | 40 | 41 | 42 | 43 | 44 | 45 |
| ↔ | | | | | | | | | | | | | | | |
| ↕ | | | | | | | | | | | | | | | |

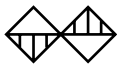

| Stitch | 1 | 2 | 3 | 4 | 5 | 6 | 7 | 8 | 9 | 10 | 11 | 12 | 13 | 14 | 15 |
|--------|----|----|----|----|----|----|----|----|----|----|----|----|----|----|----|
| ↔ | 00 | 05 | 04 | 05 | 08 | 07 | 08 | 11 | 11 | 11 | 16 | 11 | 07 | 04 | 00 |
| ↕ | 07 | 07 | 03 | 07 | 07 | 00 | 07 | 07 | 03 | 07 | 07 | 03 | 00 | 03 | 07 |
| Stitch | 16 | 17 | 18 | 19 | 20 | 21 | 22 | 23 | 24 | 25 | 26 | 27 | 28 | 29 | 30 |
| ↔ | 04 | 07 | 11 | 16 | 21 | 20 | 21 | 24 | 23 | 24 | 27 | 27 | 27 | 32 | 27 |
| ↕ | 11 | 14 | 11 | 07 | 07 | 11 | 07 | 07 | 14 | 07 | 07 | 11 | 07 | 07 | 11 |
| Stitch | 31 | 32 | 33 | 34 | 35 | 36 | 37 | 38 | 39 | 40 | 41 | 42 | 43 | 44 | 45 |
| ↔ | 23 | 20 | 16 | 20 | 23 | 27 | 32 | | | | | | | | |
| ↕ | 14 | 11 | 07 | 03 | 00 | 03 | 07 | | | | | | | | |

GENERATING THE DATA

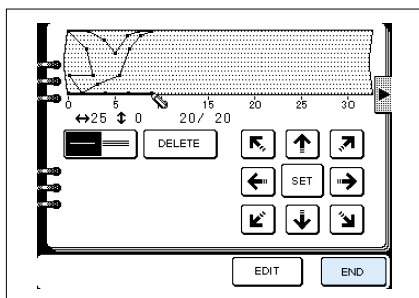
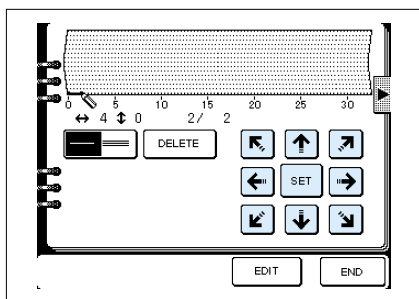
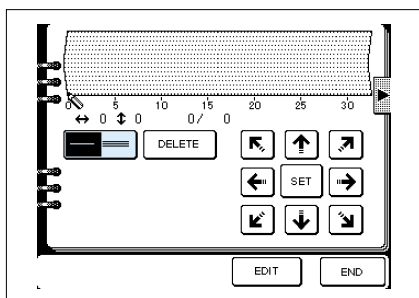
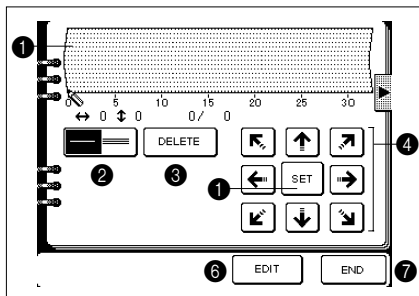
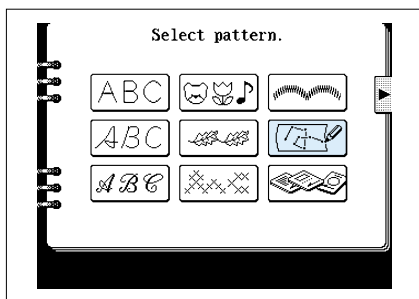



Preparation

If the embroidery unit is attached, remove.

* Turn off the power supply before removing the embroidery unit.

1. Touch the "CHARACTER/DECORATIVE STITCH" key.

2. Touch the "  " key.
The input screen will be displayed.

① Display the pattern input area. "  " indicates the pattern width, and "  " indicates the pattern length.

② Touch this key to select whether to sew one stitch or three stitches between the two points.



③ Touch this key to clear points which have been input.

④ Touch these keys to move the position to input a point.

⑤ Touch this key to set a point.

⑥ Touch this key to correct a point which has been input.

⑦ Touch this key to complete the entry and move on to the sewing screen.

3. To input the stitch which you have drawn on the grid sheet. First, select whether to sew one stitch or three stitches with the "  " key between each point. To sew one stitch, touch the key so that it appears as "  "; to sew three stitches, touch the key so that it appears as "  ". (This can be set between each point.)

4. Use the arrow keys to set the coordinates on the input screen to the same coordinates as the points which were made on the grid sheet as described in step 2 on page 160.

5. If you touch the arrow keys, the point indicated by the "  " will move in the direction of the arrow touched. If you touch "SET", a point will be entered. Repeat the above operation as many times as required to input the stitch you have drawn on the grid sheet onto the screen as a continuous line.

* If you make a mistake in entering, touch the "DELETE" key to clear the last point entered.

6. Once you have finished creating the stitch, touch the "END" key.

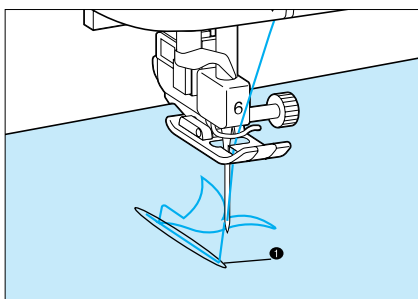
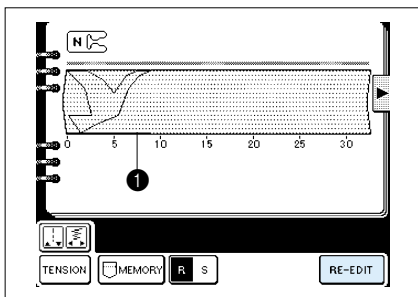

7. The sewing screen will then be displayed.

- * Touch the “RE-EDIT” key to return to the input screen and make changes to your own stitch.
- * If entering a one-point pattern and sewing the pattern continuously, make sure that you input the data for the linking stitch so that the patterns do not overlap.

① Linking stitch

- * If you have entered points which are too close together the fabric may not feed properly. Edit the points to make the space between each point larger.



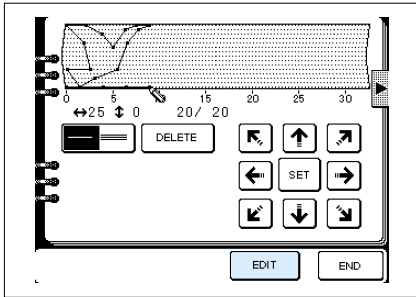

EDITING AN EXISTING “”

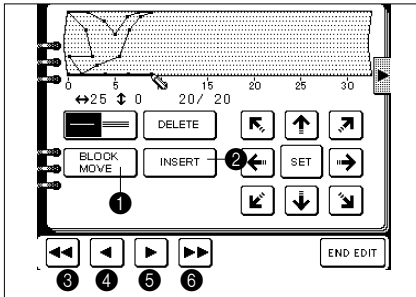

1. Touch the “EDIT” key.





The edit screen will be displayed. Move the “” to the location of the point you would like to correct and then make the correction.

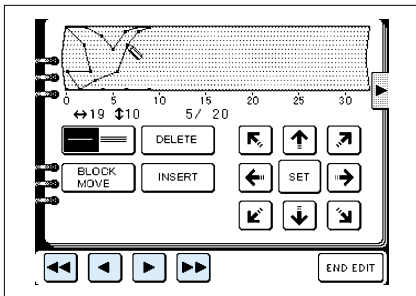

- 1 Touch this key to move part of or all of the pattern.
- 2 Touch this key if you would like to insert a point.
- 3 Touch this key to move the “” back to the starting position.
- 4 Touch this key to move the “” back one point.
- 5 Touch this key to move the “” forward one point.
- 6 Touch this key to move the “” to the last point.

Moving a point



1. Touch the “”, “”, “” or “” key to move the “” to the point which you would like to move.

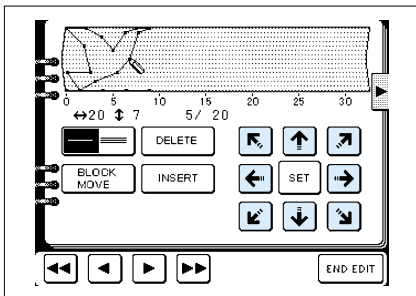

2. Touch any of the 8 directional arrow keys to move the point.

Moving part or all of a pattern

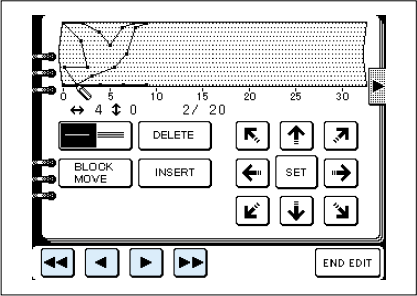

1. Touch the “”, “”, “” or “” key to move the “” to the start point which you would like to move.

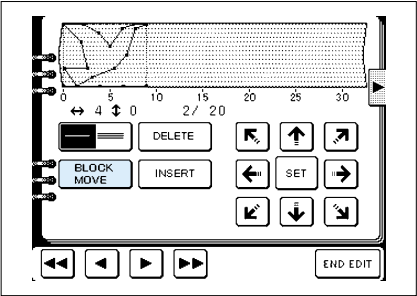

2. Touch the “BLOCK MOVE” key.
The points behind the “” will be enclosed by a “”. (This indicates the area which is to be moved.)

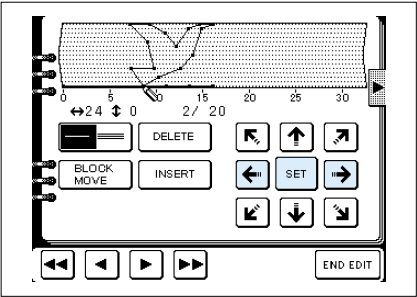

3. Touch the “” or “” key to move to the desired position, and then touch the “SET” key.

Inserting new points

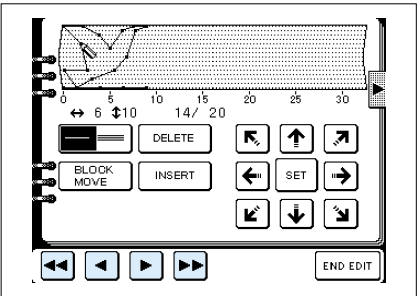

1. Touch the “”, “”, “” or “” key to move the “” to the point before the place where you would like to enter a new point.

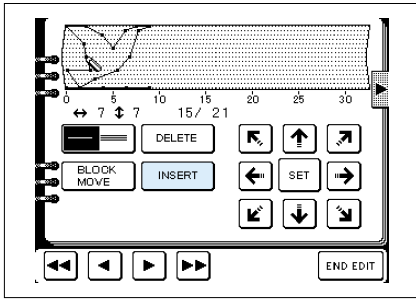

2. Touch the "INSERT" key.

A new point will be inserted and the "✎" will move to this newly- inserted point.

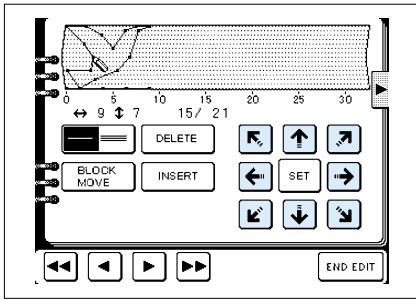

3. Use any of the 8 directional arrow keys to move the desired point.

4. Touch the "SET" key when you are finished making the changes at this coordinate point.

* Repeat step 1, 2, 3, 4 for additional editing.

Once you have finished editing

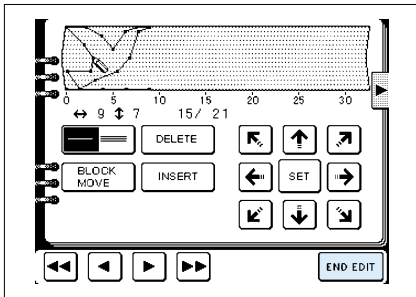

1. Touch the "END EDIT" key.
The display will return to the input screen. You can then continue to enter the pattern.

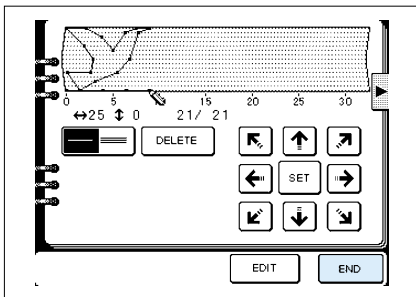

2. Touch the "END" key.

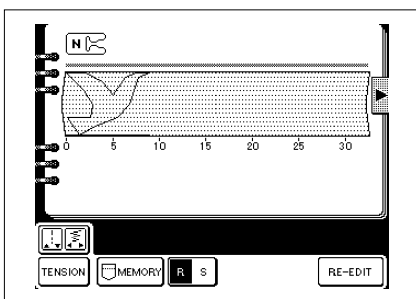

3. The sewing screen will then be displayed.

STORING THE “” WHICH YOU HAVE ENTERED

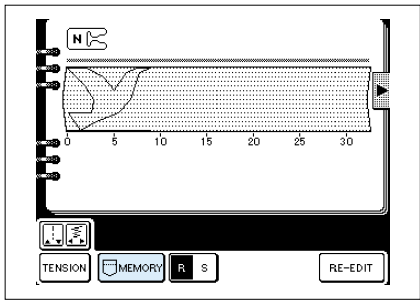

Up to five patterns can be stored, Touch the “MEMORY” key. (It will take approximately 10 seconds for the pattern to be stored.) Once the pattern has been stored, the display will return to the previous screen.

Refer to the next page for details on how to retrieve a pattern which has been stored.

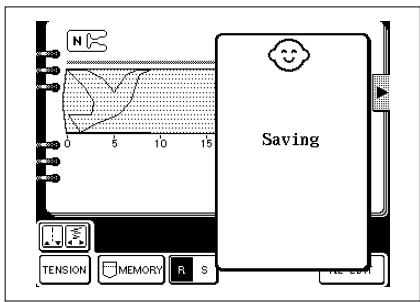

CAUTION:
Do not turn off the power while the word “Saving” is displayed. The data being stored may be deleted.

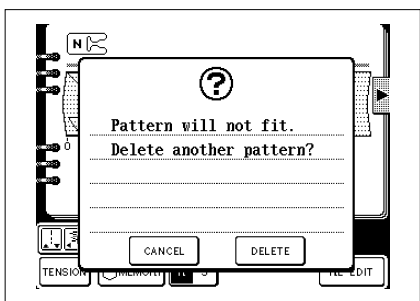

Refer to page 101 for details on what to do if the pattern cannot be stored because the memory is already full.

RETRIEVING A “”

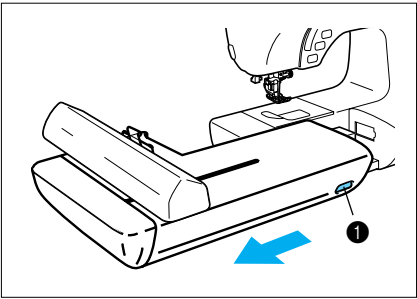

Preparation

If the embroidery unit is attached, remove it.

① Release button

* Turn off the power supply before removing the embroidery unit.

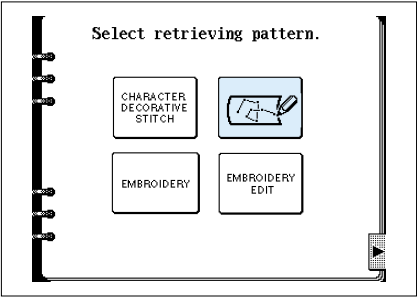

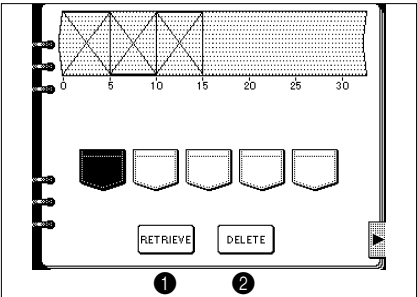

1. Touch the “MEMORY RECALL” key.

2. Touch the “” key.



The “” indicates a pocket which has a pattern saved in it.

If you touch a “”, the pattern which is saved in that pocket will be displayed.

3. Touch a “” to select a saved pattern and have it displayed.

- ① Touch this key to delete a saved pattern.
- ② Touch this key to retrieve a saved pattern.

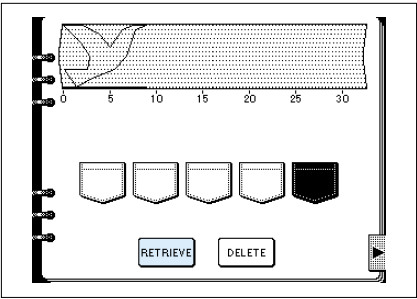

4. Touch the “RETRIEVE” key to make the selected stitch available for sewing.

* To delete a pattern touch the “DELETE” key.

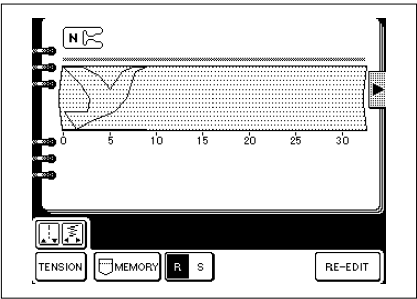

5. The sewing screen for that stitch will then be displayed.

MAINTENANCE

CLEANING

Cleaning the screen

CAUTION

Disconnect the power cord from the wall socket before cleaning the screen, otherwise injury and electric shocks may result.

If the front panel is dirty, wipe it gently with a soft, dry cloth. Do not use any organic solvents or detergents.

Cleaning the machine surface

CAUTION

Disconnect the power cord from the wall socket before cleaning the machine surface, otherwise injury and electric shocks may result.

If the surface of the machine is dirty, lightly soak a cloth in neutral detergent, squeeze it out firmly and then wipe the surface. After cleaning it once in this way, wipe it again with a dry cloth.

Cleaning the shuttle

CAUTION

Disconnect the power cord from the wall socket before cleaning the shuttle, otherwise injury and electric shocks may result.

Sewing performance will suffer and bobbin thread detection will become unreliable if dust collects in the shuttle. It should be kept clean at all times.

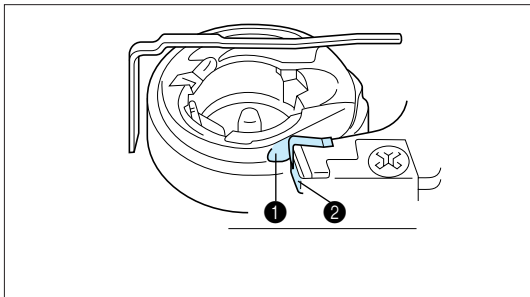
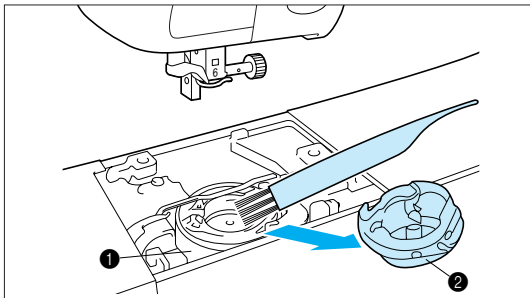
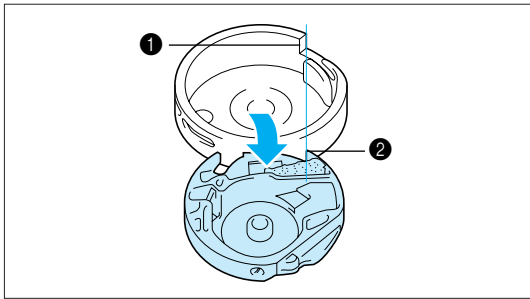
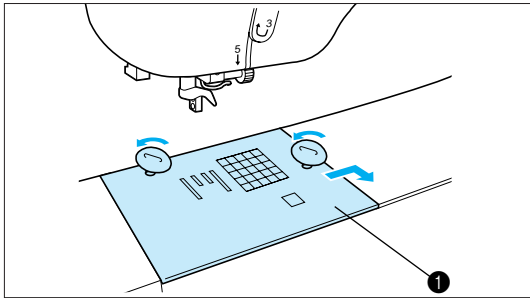
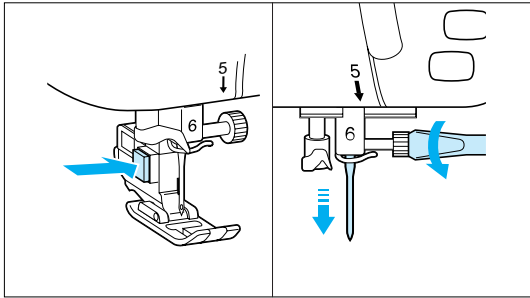

Always keep the machine clean.

1. Turn off the power and remove the presser foot holder and the needle.

2. Loosen the screws. Using the metal disk provided.

3. Remove the needle plate.

① Needle plate

4. Turn the balance wheel towards you, and align the notch of shuttle with the shelf of race edge angle, and remove the shelf of race.

① Notch of shuttle
② Shelf of race

5. Take out the shuttle.

6. Remove accumulated lint and thread from the inner shuttle and race with a brush or a vacuum cleaner.

① Race
② Shuttle

7. Set the shuttle by aligning the shuttle projection with spring of the stopper.

① Projection
② Spring

* Lint and dust accumulated in the race will sometimes cause poor stitching or malfunction of bobbin thread sensor.

CHANGING THE LIGHT BULB

When replacing the light bulb

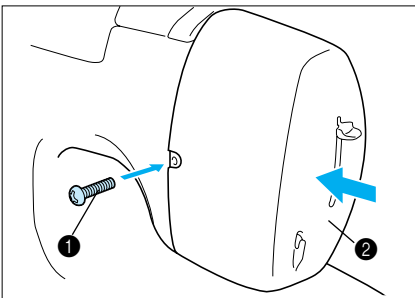
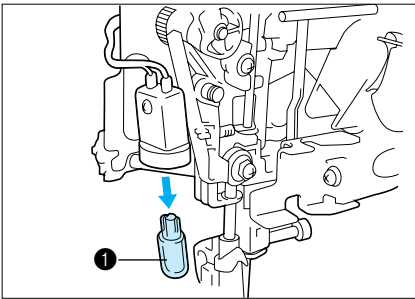
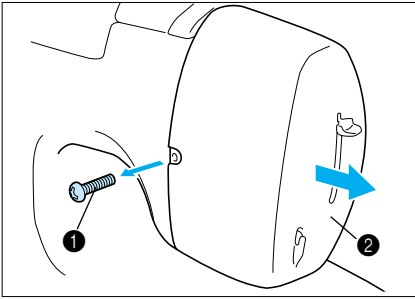

1. Turn the power off.
 - * The power cord plug must be removed from the electric outlet prior to changing the bulb.
2. Loosen the screw on the reverse side of sewing head.
3. Remove the end cap.

- ① Screw
- ② End cap

4. Replace the snap-in the light bulb with a new one.

- ① Light bulb

- * Light bulbs are available through your dealer. (12V, 5W/
Parts code XA2037001)

5. Set the end cap.
6. Tighten the screw.

- ① Screw
- ② End cap

RELATED CHART OF SEWING FABRICS, THREAD AND NEEDLE

| Sewing fabrics | | Thread | | Size of needle |
|------------------------------|--------------------|----------------------|-------|------------------------|
| | | Type | Size | |
| Medium | Broad cloth | Cotton | 60-80 | 11-14 |
| | Taffeta | Synthetic mercerized | 60-80 | |
| | Flannel, Gabardine | Silk | 50-80 | |
| Thin | Lawn | Cotton | 60-80 | 9-11 |
| | Georgette | Synthetic mercerized | 60-80 | |
| | Challis, Satin | Silk | 50-80 | |
| Thick | Denim | Cotton | 30-50 | 14-16 |
| | Corduroy | Synthetic mercerized | 50 | |
| | Tweed | Silk | 50 | |
| Stretch | Jersey | Thread for knit | | Golden needle 11-14 |
| | Tricot | | | |
| In case of top stitch thread | | Synthetic mercerized | 30 | 14-16 |
| | | Silk | 30 | |

- * For sewing on the popular stretch variety of fabrics, embroidery and decorative stitch sewing, the "Golden needle" should be used.
- * Today there are many different types of needles to suit a variety of sewing needs. Be sure to select the correct needle for a specific sewing project. For example, there are needles for denim material or needles for sewing with metallic threads.

ERROR MESSAGES

If the machine is not properly set and the “START/STOP” button is pressed, or a correction of your operating procedure is required, the machine will not start and it will instruct you with an alarm and warning message on the LCD.

Warning messages

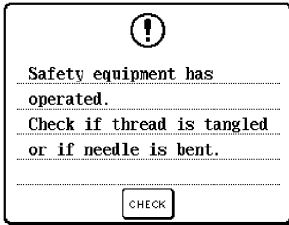

This message is displayed if motor is locked.



This message is displayed when the machine finds that the upper thread is cut.

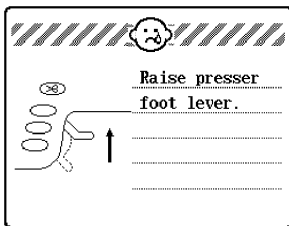

This message is displayed when the embroidery unit is trying to initialize while the embroidery foot is lowered.

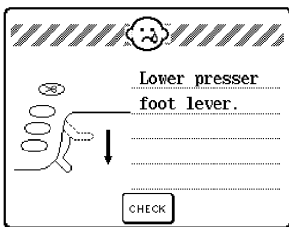

This message is displayed when the “START/STOP” or “AUTOMATIC THREAD CUTTER” button is pressed while the presser foot or embroidery foot is raised.



This message is displayed if the “CARD” key is touched while there is no memory card inserted into the slot.



This message is displayed when trying to retrieve a pattern from a memory card and that memory card is not inserted.

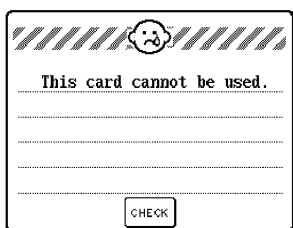

This message is displayed when the "CARD" key is touched while a memory card that cannot be read by this machine is inserted.



This message is displayed when you have tried to retrieve a pattern from one memory card while a different memory card was inserted into the slot.

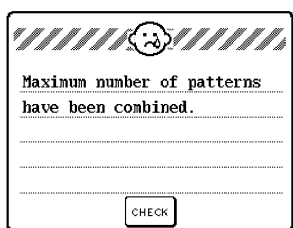

This message is displayed when you have tried to combine more than 71 patterns.

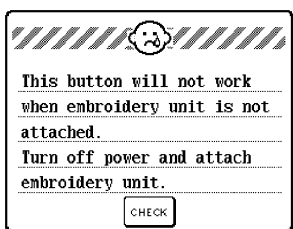

This message is displayed when the "EMBROIDERY" key or "BASIC SEWING" key is pressed when in utility stitch mode.

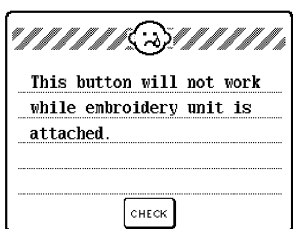

This "REVERSE STITCH" button is pressed in embroidery mode.

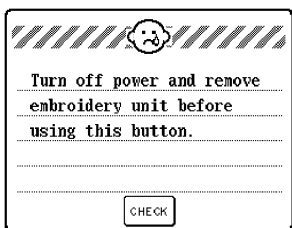

This message is displayed if the “UTILITY STITCH” or “CHARACTER/DECORATIVE STITCH” keys are touched while in embroidering mode.

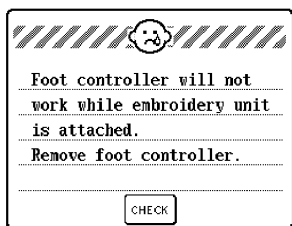

This message is displayed when the foot controller is used while the embroidery unit is connected.

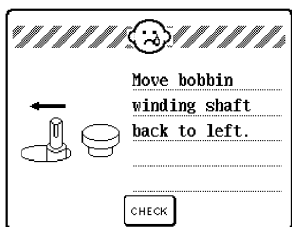

This message is displayed when the “NEEDLE POSITION” or “AUTOMATIC THREAD CUTTER” button is pressed while the bobbin winding shaft is pushed to the right.

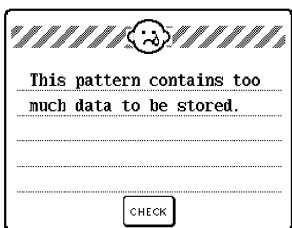

This message is displayed if the sizes of the patterns you are editing exceed the maximum size limit.

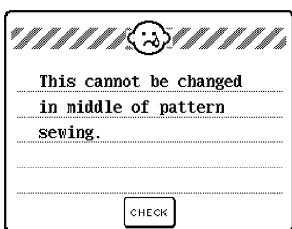

This message is displayed when the “MULTI COLOR” or “LAYOUT” key is touched during embroidering or if the machine is stopped between color changes.

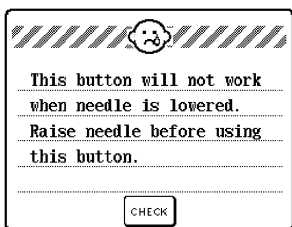

This message is displayed when a key on the screen is touched while the needle is down.

- Setting Up
- Sewing
- Utility Stitches
- Characters and Decorative Stitches
- Embroidering
- Editing Embroidery Patterns
- Retrieving
- My Custom Stitches™
- Maintenance
- Error Messages
- Trouble shooting
- Sewing Chart
- Patterns (Programmed in Machine)
- Patterns (Memory Card)

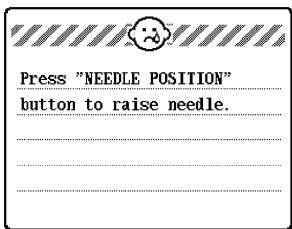

This message is displayed when the embroidery unit is attached while the needle is lowered.



This message is displayed if the "START/STOP" button is pressed while the foot controller is still connected.



This message is displayed if the "START/STOP" button is touched when in editing mode.

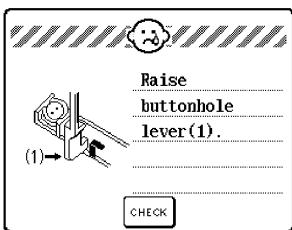

This message is displayed if a non-buttonhole pattern is selected and the "START/STOP" button or "REVERSE STITCH" button is pressed while the buttonhole lever is lowered.

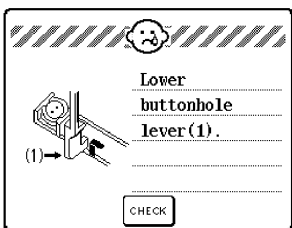

This message is displayed if a buttonhole pattern is selected and the "START/STOP" button or "REVERSE STITCH" button is pressed while the buttonhole lever is raised.

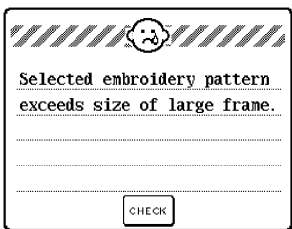

This message is displayed when the embroidery pattern is larger than the embroidery frame.

- Setting Up
- Sewing
- Utility Stitches
- Characters and Decorative Stitches
- Embroidering
- Editing Embroidery Patterns
- Retrieving
- My Custom Stitch™
- Maintenance
- Error Messages
- Trouble shooting
- Sewing Chart
- Patterns (Programmed in Machine)
- Patterns (Memory Card)

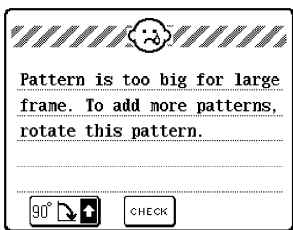

This message is displayed in embroidery mode when the combination of characters is too big to fit within the embroidery frame. You can continue to add characters if you rotate the pattern 90°.

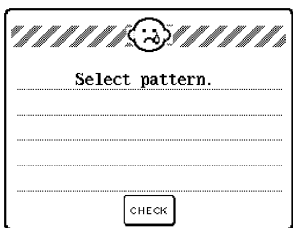

This message is displayed when any of the following are pressed, while no pattern has been selected.

- “START/STOP” button
- “REVERSE STITCH” button
- “” key
- “TENSION” key
- “” key
- “SET” key

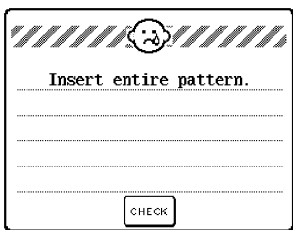

This message is displayed if the frame pattern for embroidering has not been completely input, and when the “START/STOP” button is pressed when in editing mode.

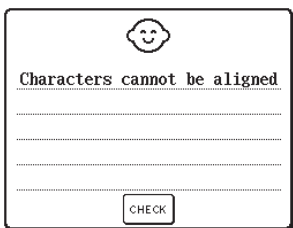

This message is displayed when curve configuration can not be performed because there are too many characters.

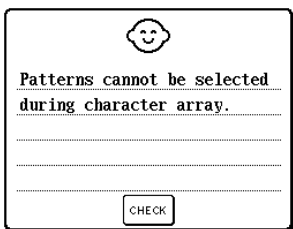

This message is displayed when a pattern is selected during character configuration.

Instruction messages

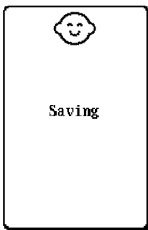

This message is displayed while a pattern is being saved into memory.

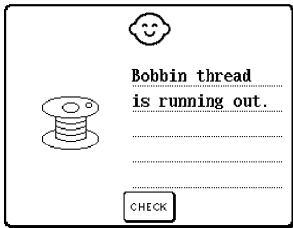

This message is displayed when the machine detects that the bobbin thread is running out.

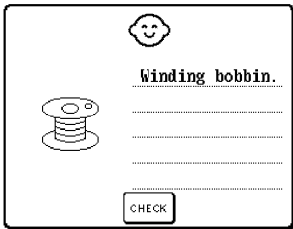

This message is displayed during bobbin winding.

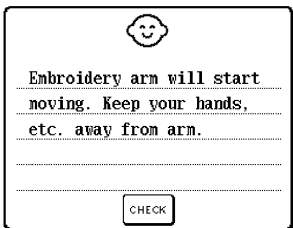

This message is displayed while the embroidery unit is initializing.

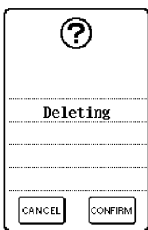

This message is displayed when a pattern which is stored in memory is deleted.

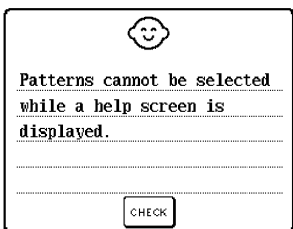

This message is displayed if a pattern is selected while a help topic is being displayed.

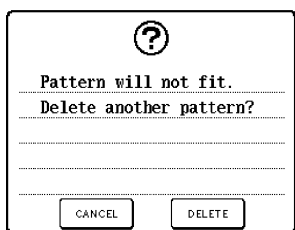

This message is displayed when the memory is full and no more patterns can be stored.

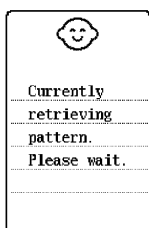

This message is displayed when a pattern is being retrieved in embroidery mode.

Alarms

- Proper operation: One beep
Incorrect operation: Two or four beeps

Setting Up

Sewing

Utility Stitches

Characters and Decorative Stitches

Embroidering

Editing Embroidery Patterns

Retrieving

My Custom Stitch™

Maintenance

Error Messages

Trouble shooting

Sewing Chart

Patterns (Programmed in Machine)

Patterns (Memory Card)

USING THE “OPERATION GUIDE” KEY

This machine is equipped with an easy to use trouble check function which provides assistance when there is a problem with sewing.

Touch the applicable heading and check the cause of the problem.

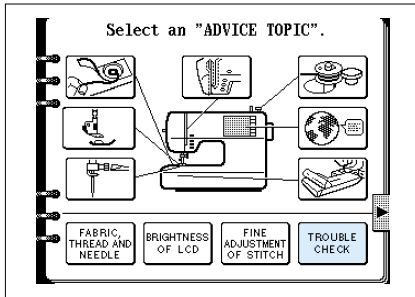

1. Touch the “OPERATION GUIDE” key and then touch the “TROUBLE CHECK” key.

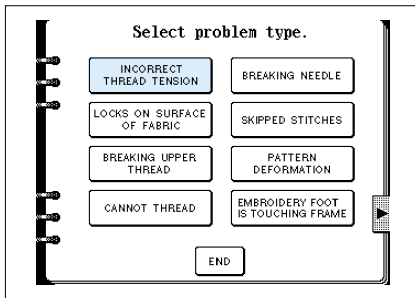

2. Select the heading which corresponds to the problem you are having.

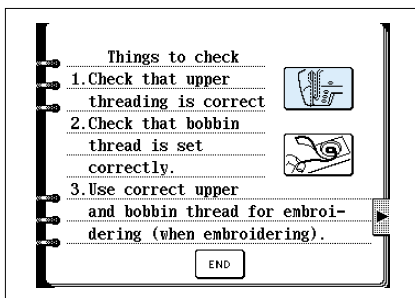

3. Check the information displayed. If you are not sure of the correct method of operation, touch the “” key beside the check heading. The method of operation will then be displayed in steps.

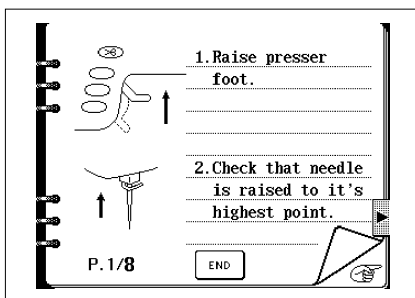

Example:

If you touch the “” key, the upper threading method is explained.

- * Touch the “END” key to return to the original screen.

Trouble with threads and stitches

Before calling for service, check the following items. If the problem still persists, contact the place of purchase or your nearest Brother dealer.

| Symptom | Probable cause | Remedy |
|--|---|--|
| 1. Upper thread breaks | 1. Upper threading is not correct. | 1. Re-thread upper thread. |
| | 2. Upper thread is tangled. | 2. Remove thread ends in the race or shuttle. |
| | 3. Spool of thread is not correctly set. | 3. Set spool of thread correctly. |
| | 4. Correct needle is not used. | 4. Change to proper needle. |
| | 5. Shuttle is damaged. | 5. Contact service center. |
| 2. Bobbin thread breaks | 1. Upper thread is tangled. | 1. Remove thread ends in the race or inner shuttle or from around spool pin. |
| | 2. Bobbin is not threaded properly in the shuttle. | 2. Set bobbin properly and pull out the bobbin thread. |
| 3. Skipped stitches | 1. Needle is not correctly inserted. | 1. Insert needle properly. |
| | 2. Correct needle is not used. | 2. Change to proper needle. |
| | 3. The combination of fabric, thread and needle is not correct. | 3. Check the "RELATED CHART OF SEWING FABRICS, THREAD AND NEEDLE" on page 172. |
| | 4. Dust is clinging under the needle plate. | 4. Remove dust by cleaning with a brush. |
| | 5. Upper threading is not correct. | 5. Re-thread upper thread. |
| 4. Fabric puckers | 1. Threading is not correct | 1. Re-thread upper and bobbin thread correctly. |
| | 2. Correct needle is not used. | 2. Change to proper needle. |
| | 3. Combination of fabric, thread and needle is not correct. | 3. Check "RELATED CHART OF SEWING FABRICS, THREAD AND NEEDLE" on page 172. |
| | 4. Check if thread tension is set at "AUTO" position, | 4. Refer to "THREAD TENSION" on page 29. |
| 5. Inability to thread needle | 1. Needle position is not collect. | 1. Set needle at proper position using "NEEDLE POSITION" button. |
| | 2. Hook of needle threader does not fit into the eye of the needle. | 2. Set needle at proper position using "NEEDLE POSITION" button. |
| 6. Inability for thread tension control | 1. Upper threading is not correct. | 1. Re-thread upper thread. |
| | 2. Set of bobbin thread is not correct. | 2. Set bobbin properly and pull out the bobbin thread. |
| | 3. Combination of fabric, thread and needle is not correct. | 3. Check "RELATED CHART OF SEWING FABRICS, THREAD AND NEEDLE" on page 172. |
| | 4. Check if the thread tension is set at "AUTO" position. | 4. Refer to "THREAD TENSION" on page 29. |

Mechanical trouble

| Symptom | Probable cause | Remedy |
|---|--|--|
| 1. Fabric is not fed properly | 1. Stitch length is set at no feeding. | 1. Set stitch length properly. |
| | 2. The combination of selected stitch and presser foot is not correct. | 2. Change presser foot to correct one. |
| | 3. Correct needle is not being used. | 3. Change to proper needle. |
| | 4. Thread is entangled. | 4. Remove thread-ends in the race or inner shuttle. |
| 2. Needle breaks | 1. Needle is not correctly inserted. | 1. Set needle properly. |
| | 2. Correct needle is not used. | 2. Change to proper needle. |
| | 3. The combination of fabric, thread and needle is not correct. | 3. Check the "RELATED CHART OF SEWING FABRICS, THREAD AND NEEDLE" on page 172. |
| | 4. The fabric is pulled too much. | 4. Sew without pulling but just guide the fabric. |
| 3. Machine is noisy, slow speed, thread trimming is not good | 1. Dust is clinging under the needle plate. | 1. Remove dust by cleaning with a brush. |
| 4. Machine does not start | 1. "START/STOP" button is not pressed. | 1. Press "START/STOP" button. |
| | 2. Main power switch is in the off position. | 2. Turn the power on. |
| | 3. Presser foot is not lowered. | 3. Lower the presser foot. |
| | 4. Check error messages. | 4. Refer to "ERROR MESSAGES" on page 173. |
| 5. Embroidery unit does not work | 1. Power switch is in the off position. | 1. Turn the power on. |
| | 2. Embroidery unit is not correctly connected to the machine. | 2. Connect embroidery unit properly to the machine. |
| | 3. Memory card is not inserted. | 3. Turn off the power then insert the memory card. |
| | 4. Check error messages. | 4. Refer to "ERROR MESSAGES" on page 173. |
| | 5. The embroidery unit was not correctly initialized. | 5. Refer to page 109. |

SEWING CHART

| SELECT KEY | NAME OF PATTERN | PATTERN | TYPE OF PRESSER FOOT | USE | REINFORCEMENT STITCH KEY | STITCH WIDTH BY STITCH ADJUSTING KEY | STITCH LENGTH BY STITCH ADJUSTING KEY | AUTOMATIC THREAD CUTTING | AUTOMATIC REINFORCEMENT STITCHING | SELECT KEY | NAME OF PATTERN | PATTERN | TYPE OF PRESSER FOOT | USE | REINFORCEMENT STITCH KEY | STITCH WIDTH BY STITCH ADJUSTING KEY | STITCH LENGTH BY STITCH ADJUSTING KEY | AUTOMATIC THREAD CUTTING | AUTOMATIC REINFORCEMENT STITCHING | | | | | | | | | | | | |
|------------------------------------|---|---------|----------------------|--|---|---|---------------------------------------|--------------------------|-----------------------------------|----------------|-------------------|----------|----------------------|------------------------------------|--|--------------------------------------|---------------------------------------|--------------------------|-----------------------------------|---------------------------------|---|--------------------------------|----------|--------------------------------|--------------------------------|--|--------------------------------|---|---|---|--|
| UTILITY STITCH | STRAIGHT | | | General sewing, gather, Pintuck, etc. | R | ★ | ★ | C | T | UTILITY STITCH | BUTTONHOLE STITCH | | | Buttonholes for jeans and trousers | | ★ | ★ | C | T | | | | | | | | | | | | |
| | | | | | R | - | ★ | C | T | | BUTTONHOLE STITCH | | | Buttonholes for thick coats | | ★ | ★ | C | T | | | | | | | | | | | | |
| | STRETCH STITCH | | | General sewing for reinforcement | △ | ★ | ★ | C | T | | BAR TACK | | | | Reinforcement at opening of pocket, etc. | | ★ | ★ | C | T | | | | | | | | | | | |
| | | | | | △ | ★ | ★ | C | T | | DARNING STITCH | | | | Darning of medium fabric | | ★ | ★ | C | T | | | | | | | | | | | |
| | ZIGZAG | | | Overcasting, Patchwork | R | ★ | ★ | C | T | | TAPE ATTACHING | | | | Attaching tape to thin and medium stretch fabric | △ | ★ | ★ | C | T | | | | | | | | | | | |
| | | | | | △ | ★ | ★ | C | T | | | | | | | EYELET | | | | For making eyelet on belt, etc. | | L | S | C | T | | | | | | |
| | ELASTIC ZIGZAG STITCH | | | Overcasting (medium, thick and stretch fabrics) Tape attaching, darning | △ | ★ | ★ | C | T | | BUTTON SEWING | | | | Attaching buttons | △ | ★ | - | C | T | | | | | | | | | | | |
| | | | | | △ | ★ | ★ | C | T | | BASTING | | | | Basting | △ | ★ | ★ | C | T | | | | | | | | | | | |
| | OVERCASTING STITCH | | | Reinforcing of thin and medium fabric | △ | ★ | ★ | C | T | | APPLIQUE | | | | Appliques | △ | ★ | ★ | C | T | | | | | | | | | | | |
| | | | | | Reinforcing of thick fabric | △ | ★ | ★ | C | | | | | | | T | SCALLOP | | | | Decorating collar of blouse, edge of handkerchief | △ | ★ | ★ | C | T | | | | | |
| | | | | | | Reinforcing of medium stretch fabric and thick fabric, decorative stitching | △ | ★ | ★ | | | | | | | C | | | | | | T | SMOCKING | | | | Smocking, decorative stitching | △ | ★ | ★ | C |
| | | | | | Reinforcing of medium, thick and easily-frayable fabric | △ | ★ | ★ | C | | | | | | | T | PATCHWORK STITCH | | | | Patchwork stitches, decorative stitching | △ | | | | | | ★ | ★ | C | T |
| | | | | | Reinforcement of stretch fabric | △ | ★ | ★ | C | | | | | | | T | | | | | | FAGOTING | | | | Patchwork stitches, decorative stitching | △ | ★ | ★ | C | T |
| | | | | | Reinforcement of stretch fabric | △ | ★ | ★ | C | | | | | | | T | | | | | | | | | | | FAGOTING | | | | Patchwork stitches, decorative stitching |
| | | | | | BLIND HEM STITCH | | | Reinforcement of skirts | △ | | | | | | | ★ | ★ | C | T | FAGOTING | | | | Fagoting, decorative stitching | △ | ★ | | | | | |
| | Reinforcement of skirts with stretch fabric | △ | ★ | ★ | | | | | C | | T | FAGOTING | | | | Fagoting, decorative stitching | △ | ★★ | ★ | | | | | | C | T | | | | | |
| | BUTTONHOLE STITCH | | | Buttonholes for blouses and shirts | | | ★ | ★ | C | | T | | | | | | FAGOTING | | | | Fagoting, decorative stitching | △ | ★ | ★ | C | T | | | | | |
| | | | | | Buttonholes for jeans and trousers | | | ★ | ★ | | C | T | FAGOTING | | | | | | | | | Fagoting, decorative stitching | △ | ★ | ★ | C | T | | | | |
| | | | | | Buttonholes for thick coats | | | ★ | ★ | | C | T | | | | | | | | | | | FAGOTING | | | | Fagoting, decorative stitching | △ | ★ | ★ | C |
| | | | | | Buttonholes for first step in making a bound | | | ★ | ★ | | C | T | FAGOTING | | | | | | | | | Fagoting, decorative stitching | | | | | | △ | ★ | ★ | C |
| Buttonholes for pajamas and shirts | | | | | | | ★ | ★ | C | T | FAGOTING | | | | | | | | | | | | | | Fagoting, decorative stitching | △ | ★ | ★ | C | T | |
| Buttonholes for stretch fabric | | | | | | | ★ | ★ | C | T | | | FAGOTING | | | | | | | | | Fagoting, decorative stitching | | | | △ | ★ | ★ | C | T | |
| Buttonholes for stretch | | | | | | | ★ | ★ | C | T | FAGOTING | | | | | | | | | | | | | | Fagoting, decorative stitching | △ | ★ | ★ | C | T | |
| Buttonholes for suits and overalls | | | | | | | ★ | ★ | C | T | | | FAGOTING | | | | | | | | | Fagoting, decorative stitching | | | | △ | ★ | ★ | C | T | |

Setting Up

Sewing

Utility Stitches

Characters and Decorative Stitches

Embroidering

Editing Embroidery Patterns

Retrieving

My Custom Stitches™

Maintenance

Error Messages

Trouble shooting



Sewing Chart

Patterns (Programmed in Machine)

Patterns (Memory Card)

| SELECT KEY | NAME OF PATTERN | PATTERN | TYPE OF PRESSER FOOT | USE | REINFORCEMENT STITCH KEY | STITCH WIDTH BY STITCH ADJUSTING KEY | STITCH LENGTH BY STITCH ADJUSTING KEY | AUTOMATIC THREAD CUTTING | AUTOMATIC REINFORCEMENT STITCHING | |
|----------------|-------------------|---------|----------------------|---|--|--------------------------------------|---------------------------------------|--------------------------|-----------------------------------|---|
| UTILITY STITCH | DECORATIVE STITCH | | | Decorative stitching for cuffs made from stretch fabric | △ | ★ | ★ | C | T | |
| | | | | Decorative stitching for cuffs made from stretch fabric | △ | ★ | ★ | C | T | |
| | | | | Decorative stitching | △ | ★ | ★ | C | T | |
| | | | | Decorative stitching of thin to medium stretch fabric | △ | ★ | ★ | C | T | |
| | | | | Decorative stitching | △ | ★ | ★ | C | T | |
| | | | | Decorative stitching | △ | ★ | ★ | C | T | |
| | LATERAL SEWING | | | | For attaching applique on tubular part | △ | - | - | C | T |
| | | | | | | △ | - | - | C | T |
| | | | | | | △ | - | - | C | T |
| | | | | | | △ | - | - | C | T |
| | | | | | | △ | - | - | C | T |
| | | | | | | △ | - | - | C | T |
| | | | | | | △ | - | - | C | T |
| | | | | | | △ | - | - | C | T |
| | | | | | | △ | - | - | C | T |
| | | | | | | △ | - | - | C | T |
| | | | | | | △ | - | - | C | T |
| | | | | | | △ | - | - | C | T |
| | HEIRLOOM | | | | Decorative hems | △ | ★ | ★ | C | T |
| | | | | | Decorative hems | △ | ★ | ★ | C | T |
| | | | | | Decorative hems | △ | ★ | ★ | C | T |
| | | | | | Decorative hems | △ | ★ | ★ | C | T |
| | | | | | Decorative hems | △ | ★ | ★ | C | T |

- Setting Up
- Sewing
- Utility Stitches
- Characters and Decorative Stitches
- Embroidering
- Editing Embroidery Patterns
- Retrieving
- My Custom Stitch™
- Maintenance
- Error Messages
- Trouble shooting
- Sewing Chart
- Patterns (Programmed in Machine)
- Patterns (Memory Card)

| SELECT KEY | NAME OF PATTERN | TYPE OF PRESSER FOOT | USE | STITCH WIDTH BY STITCH ADJUSTING KEY | | STITCH LENGTH BY STITCH ADJUSTING KEY | AUTOMATIC THREAD CUTTING | AUTOMATIC REINFORCEMENT STITCHING |
|------------|-------------------------------|---|-------------------|--------------------------------------|---|---------------------------------------|--------------------------|-----------------------------------|
| | | | | | | | | |
| CHARACTERS | ALPHABET (BLOCK) |  | Character sewing | L, S | | | C | T |
| | ALPHABET | | | L, S | | | C | T |
| | ALPHABET (Italic) | | | L, S | | | C | T |
| | DECORATIVE STITCH |  | Decorative stitch | L, S | | | - | - |
| | SATIN STITCH | | | ★ | ★ | | - | - |
| | CROSS STITCH | | | - | - | | - | - |
| | DECORATIVE 7 mm WIDTH | | | ★ | ★ | | - | - |
| EMBROIDERY | ALPHABET |  | Character sewing | - | | | C | T |
| | FRAME PATTERN | | Frame pattern | - | | | C | T |
| | ONE-POINT PATTERN | | Patterns | - | | | C | T |
| | FLORAL ALPHABET | | | - | | | C | T |
| | MEMORY CARD (SOLD SEPARATELY) | | Characters | - | | | C | T |

R : Reverse sewing while the "REVERSE STITCH" button is pressed.

△ : When the "REVERSE STITCH" button is pressed, the machine will sew three reinforcement stitches and stop.

★ : Adjustable

- : Non-adjustable

L, M, S or L, S:

Pattern size can be changed

L (Large)

M (Medium)

S (Small)

T : When the automatic reinforcement stitch is preset, reinforcement stitches will be sewn automatically at the start of sewing. Press the "REVERSE STITCH" button to sew a reinforcement stitch automatically at the finish of sewing.

T : Reinforcement stitches will be sewn automatically at the start of sewing. Press the "REVERSE STITCH" button to sew a reinforcement stitch automatically at the finish of sewing.

C : Programmed automatic thread cutting is available.

C : Automatic thread cutting is available.

PATTERNS (PROGRAMMED IN MACHINE)

Utility stitches

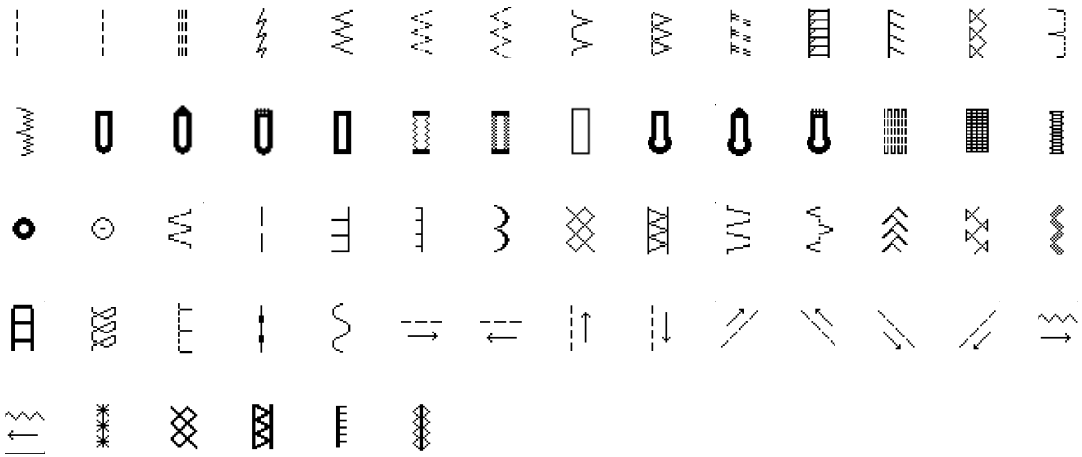

Character sewing

Alphabet (Block style)

Size "L" (Large) : 11 mm (7/16"), "S" (Small) : 7 mm (1/4")

A B C D E F G H I J K L M N O P Q R S T U V W X Y Z
 a b c d e f g h i j k l m n o p q r s t u v w x y z
 Ä Å Æ Ñ Ö Ø Ç Ü ä å æ ë è é ê ñ ö ø ì ç ü ù ß
 0 1 2 3 4 5 6 7 8 9 & ? ! □ □ □ () ' ,

Alphabet (Italic style)

Size "L" (Large) : 11 mm (7/16"), "S" (Small) : 7 mm (3/8")

*A B C D E F G H I J K L M N O P Q R S T
 U V W X Y Z
 Ä Å Æ Ñ Ö Ø Ç Ü ä å æ ë è é ê ñ ö ø ì ç ü ù ß
 a b c d e f g h i j k l m n o p q r s t u v w x y z
 0 1 2 3 4 5 6 7 8 9 & ? ! □ □ □ () ' ,*



Alphabet (Cursive hand writing style)

Size "L" (Large) : 27 mm (1"), "S" (Small) : 15 mm (3/8")

A B C D E F G H I J K L M N O P Q R S T U V W X Y Z
 a b c d e f g h i j k l m n o p q r s t u v w x y z
 Ä Å Æ Ñ Ò ä å æ è é ê ñ ö ø ï ç ü ß
 0 1 2 3 4 5 6 7 8 9 & ? ! □ □ ≡ () ' ,

Satin stitches

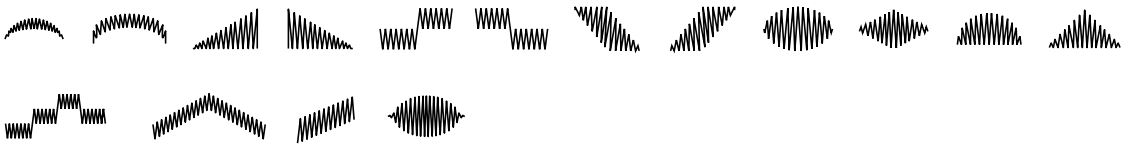

Cross stitches

Size cannot be changed.

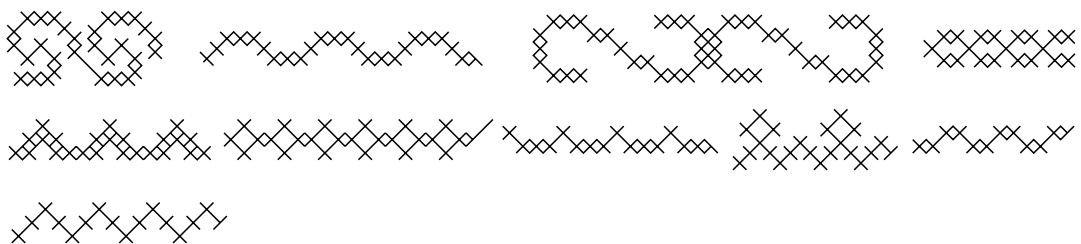

Decorative stitch

Size can be set to “L” (Large) or “S” (Small).

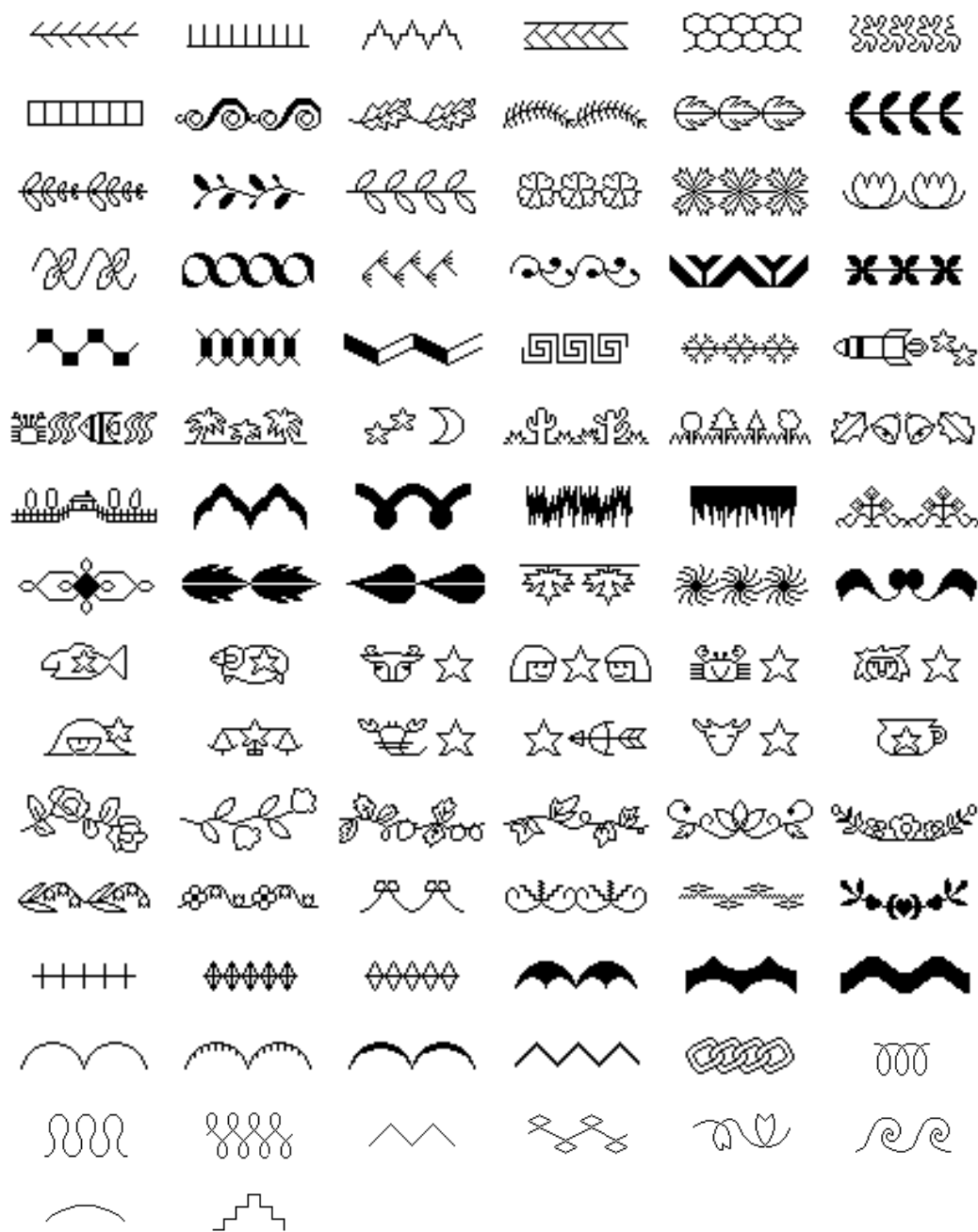

Decorative stitch 7 mm WIDTH

Stitch width and length is adjustable.

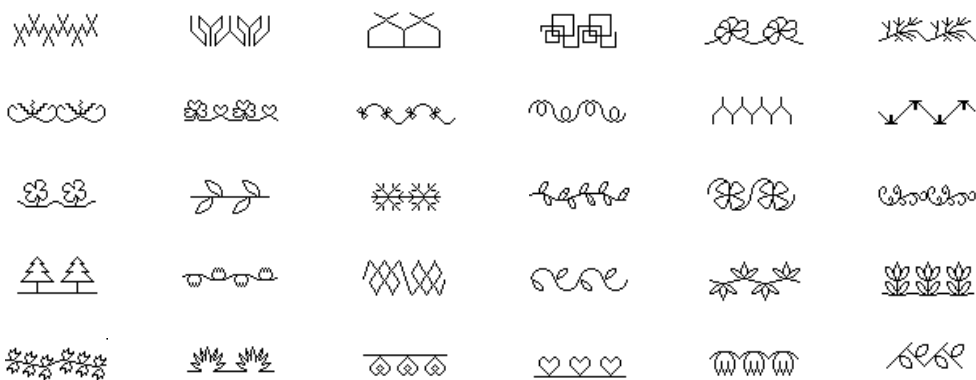

Character embroidery chart

Sizes: [L] 30 mm (1-3/16"), [M] 15 mm (9/16"), [S] 7.5 mm (1/4").

ABCDEFGHIJKLMNOPS
TUVWXYZ abcdefghijklm
nopqrstuvwxyz
ÄÅÂ Æ Ñ Ö Ø Ç Û ß ä å â æ è é ê ë ñ ö ò ø ì ç ü ù
0123456789 &?!.-_ () ' , /

ABCDEFGHIJKLMNOPS
TUVWXYZ abcdefghijklm
nopqrstuvwxyz
ÄÅÂ Æ Ñ Ö Ø Ç Û ß ä å â æ è é ê ë ñ ö ò ø ì ç ü ù
0123456789 &?!.-_ () ' , /



Frame pattern embroidery chart



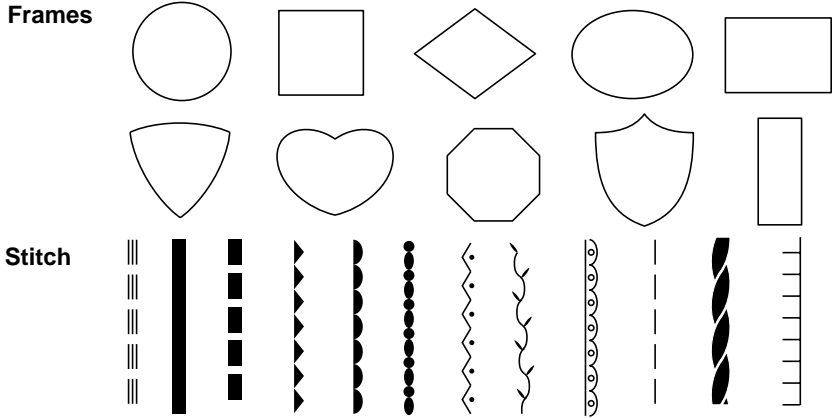

























































Sizes can be enlarged or reduced.



PATTERNS (MEMORY CARD)

One point mark embroidery pattern

<Embroidering times: 2 - 31 min. (It does not include the time needed to change colors.)>

| | | | | | | | | | |
|---|---|--|---|---|---|---|---|---|---|
|  |  |  |  |  |  |  |  |  |  |
| 1...205 2...307 3...005 4...810 | 1...339 2...214 3...307 4...001 | 1...800 2...405 3...307 4...900 | 1...307 2...205 3...214 4...900 | 1...214 2...070 3...001 4...707 | 1...001 2...070 3...307 4...214 5...800 | 1...010 2...339 3...214 4...707 | 1...208 2...507 3...030 4...405 | 1...085 2...030 3...513 4...205 | 1...085 2...513 3...507 4...205 |
|  |  |  |  |  |  |  |  |  |  |
| 1...030 2...507 3...085 4...208 | 1...507 2...205 3...030 4...513 | 1...001 2...058 3...208 4...707 5...007 | 1...502 2...085 3...208 | 1...339 2...001 3...900 | 1...001 2...405 3...017 4...208 5...205 6...900 | 1...079 2...515 3...328 4...058 5...800 | 1...800 2...001 3...843 4...323 5...900 | 1...205 2...019 3...800 4...900 | 1...800 2...205 3...405 4...800 5...900 |
|  |  |  |  |  |  |  |  |  |  |
| 1...058 | 1...800 | 1...205 2...001 3...405 4...800 5...124 6...001 7...800 8...900 | | 1...001 2...704 3...704 4...707 5...707 6...010 7...900 | 1...900 2...614 3...534 | 1...843 2...208 | 1...614 | 1...307 2...800 3...058 4...086 5...214 | 1...019 2...707 3...085 |
|  |  |  |  |  |  |  |  |  |  |
| 1...323 2...085 3...001 4...058 | 1...086 2...058 3...707 | 1...070 2...085 3...086 4...323 | 1...513 2...001 3...208 4...058 | 1...001 2...800 3...515 4...058 5...900 | 1...800 2...513 3...900 | 1...001 2...010 3...323 4...513 5...058 | 1...085 2...323 3...058 | 1...086 2...205 3...534 4...019 | 1...513 2...030 3...058 |
|  |  |  |  |  |  |  |  |  |  |
| 1...900 | 1...900 2...205 3...800 4...323 5...900 | 1...339 2...058 3...843 4...900 | 1...405 2...900 3...005 4...704 | 1...405 2...507 3...800 4...205 | 1...843 2...900 3...019 | 1...205 2...019 3...900 | 1...001 2...900 | 1...079 2...800 3...208 4...900 | 1...005 2...707 |
|  |  |  |  |  |  |  |  |  |  |
| 1...900 | 1...614 | 1...086 | 1...001 2...515 3...507 | 1...001 2...900 | 1...513 2...328 3...515 4...085 5...086 6...079 7...515 | 1...513 2...030 3...205 4...339 5...900 | 1...405 2...001 3...800 4...900 5...001 6...307 7...405 8...900 9...307 10...800 11...900 | 1...515 2...513 3...001 4...208 5...205 6...513 | 1...513 2...507 |

Patterns which are stored in the machine or memory cards are for home use only. These patterns are not to be used for any activity other than home use.

Floral alphabet



1 017
2 513
3 810
4 070
5 612
6 205



1 017
2 513
3 810
4 205
5 070
6 612



1 017
2 513
3 810
4 205
5 612
6 070

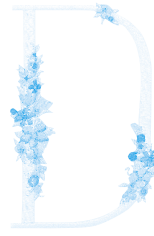

1 017
2 513
3 205
4 810
5 612
6 070

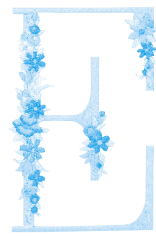

1 017
2 513
3 810
4 070
5 612
6 205

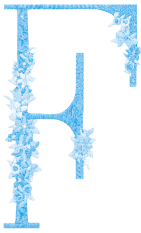

1 017
2 513
3 070
4 810
5 205
6 612



1 017
2 513
3 205
4 612
5 070
6 810

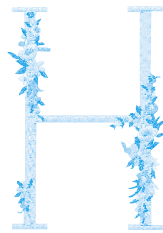

1 017
2 513
3 612
4 810
5 205
6 070



1 017
2 513
3 612
4 810
5 070
6 205



1 017
2 513
3 612
4 810
5 070
6 205

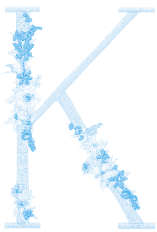

1 017
2 513
3 810
4 612
5 205
6 070

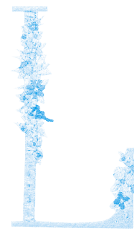

1 017
2 513
3 810
4 205
5 612
6 070

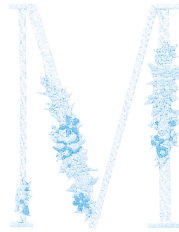

1 017
2 513
3 205
4 612
5 810
6 070

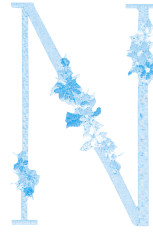

1 017
2 513
3 070
4 810
5 612
6 205



1 017
2 513
3 612
4 810
5 070
6 205

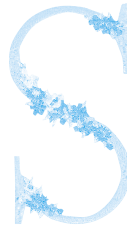

1 017
 2 513
 3 810
 4 070
 5 205
 6 612

1 017
 2 513
 3 810
 4 070
 5 205
 6 070

1 017
 2 513
 3 612
 4 070
 5 810
 6 205

1 017
 2 513
 3 810
 4 612
 5 205
 6 070

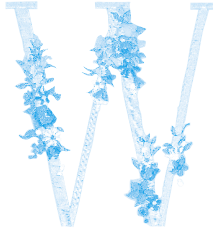
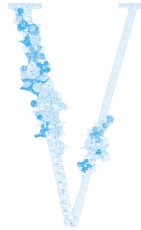
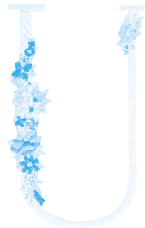
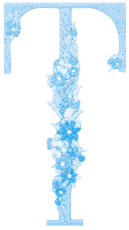

1 017
 2 513
 3 810
 4 205
 5 612
 6 070

1 017
 2 513
 3 810
 4 612
 5 070
 6 205

1 017
 2 513
 3 810
 4 070
 5 612
 6 205

1 017
 2 513
 3 612
 4 810
 5 070
 6 205

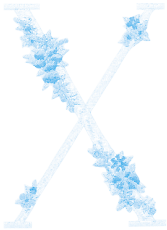

1 017
 2 513
 3 070
 4 810
 5 205
 6 612

1 017
 2 513
 3 070
 4 810
 5 612
 6 205

1 017
 2 513
 3 810
 4 205
 5 612
 6 070